

# μA79M00 SERIES

## 3-TERMINAL NEGATIVE VOLTAGE REGULATORS

### FAIRCHILD LINEAR INTEGRATED CIRCUITS

**GENERAL DESCRIPTION** — The μA79M00 series of 3-Terminal Medium Current Negative Voltage Regulators are constructed using the Fairchild Planar\* epitaxial process. These regulators employ internal current limiting, thermal shutdown and safe area compensation making them essentially indestructible. If adequate heat sinking is provided, they can deliver up to 500 mA output current. They are intended as fixed voltage regulators in a wide range of applications including local (on-card) regulation for elimination of noise and distribution problems associated with single point regulation. In addition to use as fixed voltage regulators, these devices can be used with external components to obtain adjustable output voltages and currents.

- OUTPUT CURRENT IN EXCESS OF 0.5 A
- INTERNAL THERMAL OVERLOAD PROTECTION
- INTERNAL SHORT CIRCUIT CURRENT LIMITING
- OUTPUT TRANSISTOR SAFE AREA COMPENSATION
- AVAILABLE IN JEDEC TO-220 AND TO-39 PACKAGES
- OUTPUT VOLTAGES OF -5 V, -6 V, -8 V, -12 V, -15 V, -20 V AND -24 V

**ABSOLUTE MAXIMUM RATINGS**

Input Voltage		
(-5 V through -15 V)		-35 V
(-20 V, -24 V)		-40 V
Internal Power Dissipation		Internally Limited
Storage Temperature Range		
TO-39	-65°C to +150°C	
TO-220	-55°C to +125°C	
Operating Junction Temperature Range		
TO-39 Military (μA79M00)	-55°C to +150°C	
Commercial (μA79M00C)	0°C to +150°C	
TO-220 Commercial (μA79M00C)	0°C to +150°C	
Lead Temperature (Soldering, 60 s) TO-39	300°C	
(Soldering, 10 s) T)-220	230°C	

**EQUIVALENT CIRCUIT**

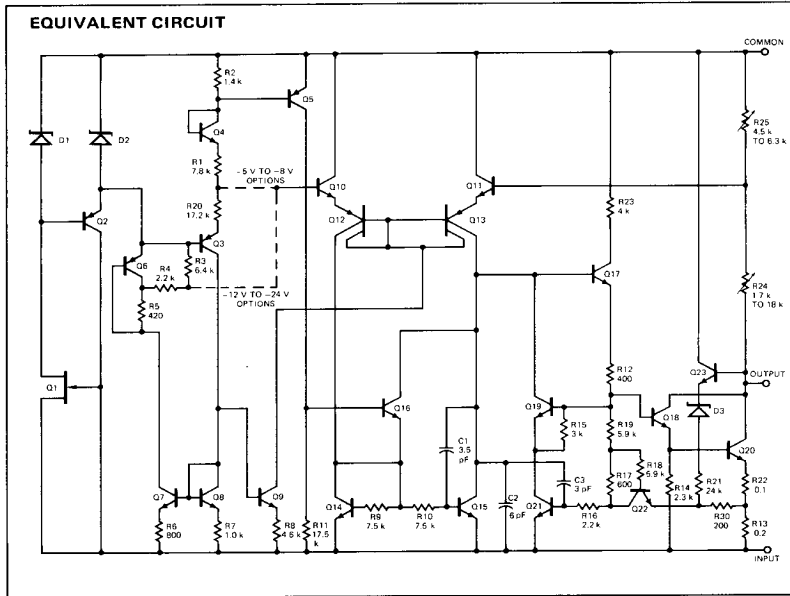

**CONNECTION DIAGRAMS**  
TO-39 PACKAGE  
(TOP VIEW)

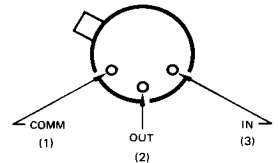

**ORDER INFORMATION**

OUTPUT VOLTAGE	PART NO.	PART NO.
-5 V	μA 79M05HM	μA 79M05AHC
-6 V	μA 79M06HM	μA 79M06AHC
✓ -8 V	μA 79M08HM	μA 79M08AHC
-12 V	μA 79M12HM	μA 79M12AHC
✓ -15 V	μA 79M15HM	μA 79M15AHC
-20 V	μA 79M20HM	μA 79M20AHC
✓ -24 V	μA 79M24HM	μA 79M24AHC

**TO-220 PACKAGE**  
(SIDE VIEW)

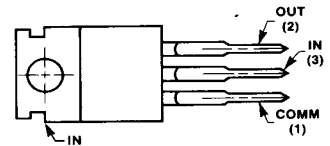

**ORDER INFORMATION**

OUTPUT VOLTAGE	PART NO.
-5 V	μA 79M05AUC
-6 V	μA 79M06AUC
-8 V	μA 79M08AUC
-12 V	μA 79M12AUC
-15 V	μA 79M15AUC
-20 V	μA 79M20AUC
-24 V	μA 79M24AUC

\*Planar is a patented Fairchild process.

# FAIRCHILD • $\mu$ A79M00 SERIES

## $\mu$ A79M05HM

**ELECTRICAL CHARACTERISTICS:**  $V_{IN} = -10$  V,  $I_{OUT} = 350$  mA,  $-55^{\circ}\text{C} \leq T_J \leq 150^{\circ}\text{C}$ ,  $C_{IN} = 2$   $\mu$ F,  $C_{OUT} = 1$   $\mu$ F, unless otherwise specified. Notes 1 and 2

CHARACTERISTICS		CONDITIONS (Note 3)	MIN	TYP	MAX	UNITS
Output Voltage		$T_J = 25^{\circ}\text{C}$	-5.2	-5.0	-4.8	V
Line Regulation		$T_J = 25^{\circ}\text{C}$ $-25\text{ V} \leq V_{IN} \leq -7\text{ V}$		7.0	50	mV
		$-18\text{ V} \leq V_{IN} \leq -8\text{ V}$		3.0	30	mV
Load Regulation		$T_J = 25^{\circ}\text{C}$ , $5\text{ mA} \leq I_{OUT} \leq 500\text{ mA}$		75	100	mV
		$T_J = 25^{\circ}\text{C}$ , $5\text{ mA} \leq I_{OUT} \leq 350\text{ mA}$		50		mV
Output Voltage		$-25\text{ V} \leq V_{IN} \leq -7\text{ V}$ , $5\text{ mA} \leq I_{OUT} \leq 350\text{ mA}^*$	-5.25		-4.75	V
Quiescent Current		$T_J = 25^{\circ}\text{C}$		1.0	2.0	mA
Quiescent Current Change		with line $-25\text{ V} \leq V_{IN} \leq -8\text{ V}$			0.4	mA
		with load $5\text{ mA} \leq I_{OUT} \leq 350\text{ mA}$			0.4	mA
Output Noise Voltage		$T_A = 25^{\circ}\text{C}$ , $10\text{ Hz} \leq f \leq 100\text{ kHz}$		25	80	$\mu\text{V}/\text{V}_{OUT}$
Ripple Rejection		$-18\text{ V} \leq V_{IN} \leq -8\text{ V}$ , $I_{OUT} = 100\text{ mA}$ $f = 120\text{ Hz}$ , $I_{OUT} = 300\text{ mA}$ , $T_J = 25^{\circ}\text{C}$	50	60		dB
Dropout Voltage		$T_J = 25^{\circ}\text{C}$		1.1	2.3	V
Short Circuit Current		$T_J = 25^{\circ}\text{C}$ , $V_{IN} = -35\text{ V}$			0.6	A
Peak Output Current			0.4	0.65	1.4	A
Average Temperature Coefficient of Output Voltage		$I_{OUT} = 5\text{ mA}$ $-55^{\circ}\text{C} \leq T_J \leq +150^{\circ}\text{C}$			0.3	$\text{mV}/^{\circ}\text{C}/\text{V}_{OUT}$

## $\mu$ A79M05AHC AND $\mu$ A79M05AUC

**ELECTRICAL CHARACTERISTICS:**  $V_{IN} = -10$  V,  $I_{OUT} = 350$  mA,  $0^{\circ}\text{C} \leq T_J \leq 125^{\circ}\text{C}$ ,  $C_{IN} = 2$   $\mu$ F,  $C_{OUT} = 1$   $\mu$ F, unless otherwise specified.

CHARACTERISTICS		CONDITIONS (Note 3)	MIN	TYP	MAX	UNITS
Output Voltage		$T_J = 25^{\circ}\text{C}$	-5.2	-5.0	-4.8	V
Line Regulation		$T_J = 25^{\circ}\text{C}$ $-25\text{ V} \leq V_{IN} \leq -7\text{ V}$		7.0	50	mV
		$-18\text{ V} \leq V_{IN} \leq -8\text{ V}$		3.0	30	mV
Load Regulation		$T_J = 25^{\circ}\text{C}$ , $5\text{ mA} \leq I_{OUT} \leq 500\text{ mA}$		75	100	mV
		$T_J = 25^{\circ}\text{C}$ , $5\text{ mA} \leq I_{OUT} \leq 350\text{ mA}$		50		mV
Output Voltage		$-25\text{ V} \leq V_{IN} \leq -7\text{ V}$ , $5\text{ mA} \leq I_{OUT} \leq 350\text{ mA}^*$	-5.25	5.0	-4.75	V
Quiescent Current		$T_J = 25^{\circ}\text{C}$		1.0	2.0	mA
Quiescent Current Change		with line $-25\text{ V} \leq V_{IN} \leq -8\text{ V}$			0.4	mA
		with load $5\text{ mA} \leq I_{OUT} \leq 350\text{ mA}$			0.4	mA
Output Noise Voltage		$T_A = 25^{\circ}\text{C}$ , $10\text{ Hz} \leq f \leq 100\text{ kHz}$		125		$\mu\text{V}$
Ripple Rejection		$-18\text{ V} \leq V_{IN} \leq -8\text{ V}$ , $I_{OUT} = 100\text{ mA}$ $f = 120\text{ Hz}$ , $I_{OUT} = 300\text{ mA}$ , $T_J = 25^{\circ}\text{C}$	50	60		dB
Dropout Voltage		$T_J = 25^{\circ}\text{C}$		1.1		V
Short Circuit Current		$T_J = 25^{\circ}\text{C}$ , $V_{IN} = -30\text{ V}$		140		mA
Peak Output Current				650		mA
Average Temperature Coefficient of Output Voltage		$I_{OUT} = 5\text{ mA}$			-0.4	$\text{mV}/^{\circ}\text{C}$

\* $P_D \leq 4$  W

**NOTES:**

- See Test Circuit.
- The convention for negative regulators is the algebraic values, thus  $-15$  V is less than  $-10$  V.
- All characteristics except noise voltage and ripple rejection ratio are measured using pulse techniques ( $t_w \leq 10$  ms, duty cycle  $\leq 5\%$ ). Output voltage changes due to changes in internal temperature must be taken into account separately.

*AHU*  
*QM*  
*QB*      *+UC*

# FAIRCHILD • $\mu$ A79M00 SERIES

## $\mu$ A79M06HM

**ELECTRICAL CHARACTERISTICS:**  $V_{IN} = -11$  V,  $I_{OUT} = 350$  mA,  $-55^{\circ}\text{C} \leq T_J \leq 150^{\circ}\text{C}$ ,  $C_{IN} = 2$   $\mu$ F,  $C_{OUT} = 1$   $\mu$ F, unless otherwise specified.

CHARACTERISTICS	CONDITIONS (Note 1)	MIN	TYP	MAX	UNITS
Output Voltage	$T_J = 25^{\circ}\text{C}$	-6.25	-6.0	-5.75	V
Line Regulation	$T_J = 25^{\circ}\text{C}$	$-25\text{ V} \leq V_{IN} \leq -8\text{ V}$	7.0	60	mV
		$-19\text{ V} \leq V_{IN} \leq -9\text{ V}$	3.0	40	mV
Load Regulation	$T_J = 25^{\circ}\text{C}$ , $5\text{ mA} \leq I_{OUT} \leq 500\text{ mA}$		80	120	mV
	$T_J = 25^{\circ}\text{C}$ , $5\text{ mA} \leq I_{OUT} \leq 350\text{ mA}^*$		55		mV
Output Voltage	$-25\text{ V} \leq V_{IN} \leq -8\text{ V}$ , $5\text{ mA} \leq I_{OUT} \leq 350\text{ mA}^*$	-6.3		-5.7	V
Quiescent Current	$T_J = 25^{\circ}\text{C}$		1.0	2.0	mA
Quiescent Current Change	with line	$-25\text{ V} \leq V_{IN} \leq -9\text{ V}$		0.4	mA
	with load	$5\text{ mA} \leq I_{OUT} \leq 350\text{ mA}$		0.4	mA
Output Noise Voltage	$T_A = 25^{\circ}\text{C}$ , $10\text{ Hz} \leq f \leq 100\text{ kHz}$		25	80	$\mu\text{V}/V_{OUT}$
Ripple Rejection	$-19\text{ V} \leq V_{IN} \leq -9\text{ V}$ , $I_{OUT} = 100\text{ mA}$	50			dB
	$f = 120\text{ Hz}$ , $I_{OUT} = 300\text{ mA}$ , $T_J = 25^{\circ}\text{C}$	54	60		dB
Dropout Voltage	$T_J = 25^{\circ}\text{C}$		1.1	2.3	V
Short Circuit Current	$T_J = 25^{\circ}\text{C}$ , $V_{IN} = -35\text{ V}$			0.6	A
Peak Output Current		0.4	0.65	1.4	A
Average Temperature Coefficient of Output Voltage	$I_{OUT} = 5\text{ mA}$ , $-55^{\circ}\text{C} \leq T_J \leq +150^{\circ}\text{C}$			0.3	$\text{mV}/^{\circ}\text{C}/V_{OUT}$

AHC

## $\mu$ A79M06AHC AND $\mu$ A79M06AUC

**ELECTRICAL CHARACTERISTICS:**  $V_{IN} = -11$  V,  $I_{OUT} = 350$  mA,  $0^{\circ}\text{C} \leq T_J \leq 125^{\circ}\text{C}$ ,  $C_{IN} = 2$   $\mu$ F,  $C_{OUT} = 1$   $\mu$ F, unless otherwise specified.

CHARACTERISTICS	CONDITIONS (Note 1)	MIN	TYP	MAX	UNITS
Output Voltage	$T_J = 25^{\circ}\text{C}$	-6.25	-6.0	-5.75	V
Line Regulation	$T_J = 25^{\circ}\text{C}$	$-25\text{ V} \leq V_{IN} \leq -8\text{ V}$	7.0	60	mV
		$-19\text{ V} \leq V_{IN} \leq -9\text{ V}$	3.0	40	mV
Load Regulation	$T_J = 25^{\circ}\text{C}$ , $5\text{ mA} \leq I_{OUT} \leq 500\text{ mA}$		80	120	mV
	$T_J = 25^{\circ}\text{C}$ , $5\text{ mA} \leq I_{OUT} \leq 350\text{ mA}$		55		mV
Output Voltage	$-25\text{ V} \leq V_{IN} \leq -8\text{ V}$ , $5\text{ mA} \leq I_{OUT} \leq 350\text{ mA}$	-6.3		-5.7	V
Quiescent Current	$T_J = 25^{\circ}\text{C}$		1.0	2.0	mA
Quiescent Current Change	with line	$-25\text{ V} \leq V_{IN} \leq -9\text{ V}$		0.4	mA
	with load	$5\text{ mA} \leq I_{OUT} \leq 350\text{ mA}$		0.4	mA
Output Noise Voltage	$T_A = 25^{\circ}\text{C}$ , $10\text{ Hz} \leq f \leq 100\text{ kHz}$		150		$\mu\text{V}$
Ripple Rejection	$-19\text{ V} \leq V_{IN} \leq -9\text{ V}$ , $I_{OUT} = 100\text{ mA}$	50			dB
	$f = 120\text{ Hz}$ , $I_{OUT} = 300\text{ mA}$ , $T_J = 25^{\circ}\text{C}$	54	60		dB
Dropout Voltage	$T_J = 25^{\circ}\text{C}$		1.1		V
Short Circuit Current	$T_J = 25^{\circ}\text{C}$ , $V_{IN} = -30\text{ V}$		140		mA
Peak Output Current			650		mA
Average Temperature Coefficient of Output Voltage	$I_{OUT} = 5\text{ mA}$		-0.4		$\text{mV}/^{\circ}\text{C}$

\* $P_D \leq 4$  W

NOTE:

- All characteristics except noise voltage and ripple rejection ratio are measured using pulse techniques ( $t_w \leq 10$  ms, duty cycle  $\leq 5\%$ ). Output voltage changes due to changes in internal temperature must be taken into account separately.

$\mu$ A79M08HM

**ELECTRICAL CHARACTERISTICS:**  $V_{IN} = -14$  V,  $I_{OUT} = 350$  mA,  $-55^{\circ}C \leq T_J \leq 150^{\circ}C$ ,  $C_{IN} = 2$   $\mu$ F,  $C_{OUT} = 1$   $\mu$ F, unless otherwise specified.

CHARACTERISTICS		CONDITIONS (Note 1)	MIN	TYP	MAX	UNITS
Output Voltage		$T_J = 25^{\circ}C$	-8.3	-8.0	-7.7	V
Line Regulation		$T_J = 25^{\circ}C$ $-25$ V $\leq V_{IN} \leq -10.5$ V		8.0	80	mV
		$-21$ V $\leq V_{IN} \leq -11$ V		4.0	50	mV
Load Regulation		$T_J = 25^{\circ}C$ , $5$ mA $\leq I_{OUT} \leq 500$ mA		90	160	mV
		$T_J = 25^{\circ}C$ , $5$ mA $\leq I_{OUT} \leq 350$ mA		60		mV
Output Voltage		$-25$ V $\leq V_{IN} \leq -10.5$ V, $5$ mA $\leq I_{OUT} \leq 350$ mA*	-8.4	<del>5.0</del>	-7.6	V
Quiescent Current		$T_J = 25^{\circ}C$		<del>1.0</del>	2.0	mA
Quiescent Current Change	with line	$-25$ V $\leq V_{IN} \leq -10.5$ V			0.4	mA
	with load	$5$ mA $\leq I_{OUT} \leq 350$ mA			0.4	mA
Output Noise Voltage		$T_A = 25^{\circ}C$ , $10$ Hz $\leq f \leq 100$ kHz		25	80	$\mu$ V/V <sub>OUT</sub>
Ripple Rejection		$-21.5$ V $\leq V_{IN} \leq -11.5$ V, $I_{OUT} = 100$ mA	50			dB
		$f = 120$ Hz, $-21$ V $\leq V_{IN} \leq -11$ V, $I_{OUT} = 300$ mA, $T_J = 25^{\circ}C$	54	59		dB
Dropout Voltage		$T_J = 25^{\circ}C$		1.1	2.3	V
Short Circuit Current		$T_J = 25^{\circ}C$ , $V_{IN} = -35$ V			0.6	A
Peak Output Current			0.4	0.65	1.4	A
Average Temperature Coefficient of Output Voltage		$I_{OUT} = 5$ mA, $-55^{\circ}C \leq T_J \leq +150^{\circ}C$			0.3	mV/ $^{\circ}C$ /V <sub>OUT</sub>

$\mu$ A79M08AHC AND  $\mu$ A79M08AUC

**ELECTRICAL CHARACTERISTICS:**  $V_{IN} = -14$  V,  $I_{OUT} = 350$  mA,  $0^{\circ}C \leq T_J \leq 125^{\circ}C$ ,  $C_{IN} = 2$   $\mu$ F,  $C_{OUT} = 1$   $\mu$ F, unless otherwise specified.

CHARACTERISTICS		CONDITIONS (Note 1)	MIN	TYP	MAX	UNITS
Output Voltage		$T_J = 25^{\circ}C$	-8.3	-8.0	-7.7	V
Line Regulation		$T_J = 25^{\circ}C$ $-25$ V $\leq V_{IN} \leq -10.5$ V		8.0	80	mV
		$-21$ V $\leq V_{IN} \leq -11$ V		4.0	50	mV
Load Regulation		$T_J = 25^{\circ}C$ , $5$ mA $\leq I_{OUT} \leq 500$ mA		90	160	mV
		$T_J = 25^{\circ}C$ , $5$ mA $\leq I_{OUT} \leq 350$ mA		60		mV
Output Voltage		$-25$ V $\leq V_{IN} \leq -10.5$ V, $5$ mA $\leq I_{OUT} \leq 350$ mA	-8.4		-7.6	V
Quiescent Current		$T_J = 25^{\circ}C$		1.0	2.0	mA
Quiescent Current Change	with line	$-25$ V $\leq V_{IN} \leq -10.5$ V			0.4	mA
	with load	$5$ mA $\leq I_{OUT} \leq 350$ mA			0.4	mA
Output Noise Voltage		$T_A = 25^{\circ}C$ , $10$ Hz $\leq f \leq 100$ kHz		200		$\mu$ V
Ripple Rejection		$-21.5$ V $\leq V_{IN} \leq -11.5$ V, $I_{OUT} = 100$ mA	50			dB
		$f = 120$ Hz, $-21$ V $\leq V_{IN} \leq -11$ V, $I_{OUT} = 300$ mA, $T_J = 25^{\circ}C$	54	59		dB
Dropout Voltage		$T_J = 25^{\circ}C$		1.1		V
Short Circuit Current		$T_J = 25^{\circ}C$ , $V_{IN} = -30$ V		140		mA
Peak Output Current				650		mA
Average Temperature Coefficient of Output Voltage		$I_{OUT} = 5$ mA			-0.6	mV/ $^{\circ}C$

\* $P_D \leq 4$  W

NOTE:

- All characteristics except noise voltage and ripple rejection ratio are measured using pulse techniques ( $t_w \leq 10$  ms, duty cycle  $\leq 5\%$ ). Output voltage changes due to changes in internal temperature must be taken into account separately.

# FAIRCHILD • $\mu$ A79M00 SERIES

## $\mu$ A79M12HM

**ELECTRICAL CHARACTERISTICS:**  $V_{IN} = -11$  V,  $I_{OUT} = 350$  mA,  $-55^{\circ}\text{C} \leq T_J \leq 150^{\circ}\text{C}$ ,  $C_{IN} = 2$   $\mu$ F,  $C_{OUT} = 1$   $\mu$ F, unless otherwise specified.

CHARACTERISTICS		CONDITIONS (Note 1)	MIN	TYP	MAX	UNITS
Output Voltage		$T_J = 25^{\circ}\text{C}$	-12.5	-12	-11.5	V
Line Regulation		$T_J = 25^{\circ}\text{C}$ $-30\text{ V} \leq V_{IN} \leq -14.5\text{ V}$		9.0	80	mV
		$-25\text{ V} \leq V_{IN} \leq -15\text{ V}$		5.0	50	mV
Load Regulation		$T_J = 25^{\circ}\text{C}$ , $5\text{ mA} \leq I_{OUT} \leq 500\text{ mA}$		65	240	mV
		$T_J = 25^{\circ}\text{C}$ , $5\text{ mA} \leq I_{OUT} \leq 350\text{ mA}$		45		mV
Output Voltage		$-30\text{ V} \leq V_{IN} \leq -14.5\text{ V}$ , $5\text{ mA} \leq I_{OUT} \leq 350\text{ mA}^*$	-12.6	5.0	-11.4	V
Quiescent Current		$T_J = 25^{\circ}\text{C}$		1.5	3.0	mA
Quiescent Current Change	with line	$-30\text{ V} \leq V_{IN} \leq -14.5\text{ V}$			0.4	mA
	with load	$5\text{ mA} \leq I_{OUT} \leq 350\text{ mA}$			0.4	mA
Output Noise Voltage		$T_A = 25^{\circ}\text{C}$ , $10\text{ Hz} \leq f \leq 100\text{ kHz}$		25	80	$\mu\text{V}/\sqrt{V_{OUT}}$
Ripple Rejection		$-25\text{ V} \leq V_{IN} \leq -15\text{ V}$ , $I_{OUT} = 100\text{ mA}$	50			dB
		$f = 120\text{ Hz}$ , $I_{OUT} = 300\text{ mA}$ , $T_J = 25^{\circ}\text{C}$	54	60		dB
Dropout Voltage		$T_J = 25^{\circ}\text{C}$		1.1	2.3	V
Short Circuit Current		$T_J = 25^{\circ}\text{C}$ , $V_{IN} = -35\text{ V}$			0.6	A
Peak Output Current			0.4	0.65	1.4	A
Average Temperature Coefficient of Output Voltage		$I_{OUT} = 5\text{ mA}$ , $-55^{\circ}\text{C} \leq T_J \leq +150^{\circ}\text{C}$			0.3	$\text{mV}/^{\circ}\text{C}/V_{OUT}$

## $\mu$ A79M12AHC AND $\mu$ A79M12AUC

**ELECTRICAL CHARACTERISTICS:**  $V_{IN} = -19$  V,  $I_{OUT} = 350$  mA,  $0^{\circ}\text{C} < T_J < 125^{\circ}\text{C}$ ,  $C_{IN} = 2$   $\mu$ F,  $C_{OUT} = 1$   $\mu$ F, unless otherwise specified.

CHARACTERISTICS		CONDITIONS (Note 1)	MIN	TYP	MAX	UNITS
Output Voltage		$T_J = 25^{\circ}\text{C}$	-12.5	-12	-11.5	V
Line Regulation		$T_J = 25^{\circ}\text{C}$ $-30\text{ V} \leq V_{IN} \leq -14.5\text{ V}$		9.0	80	mV
		$-25\text{ V} \leq V_{IN} \leq -15\text{ V}$		5.0	50	mV
Load Regulation		$T_J = 25^{\circ}\text{C}$ , $5\text{ mA} \leq I_{OUT} \leq 500\text{ mA}$		65	240	mV
		$T_J = 25^{\circ}\text{C}$ , $5\text{ mA} \leq I_{OUT} \leq 350\text{ mA}$		45		mV
Output Voltage		$-30\text{ V} \leq V_{IN} \leq -14.5\text{ V}$ , $5\text{ mA} \leq I_{OUT} \leq 350\text{ mA}$	-12.6	5.0	-11.4	V
Quiescent Current		$T_J = 25^{\circ}\text{C}$		1.5	3.0	mA
Quiescent Current Change	with line	$-30\text{ V} \leq V_{IN} \leq -14.5\text{ V}$			0.4	mA
	with load	$5\text{ mA} \leq I_{OUT} \leq 350\text{ mA}$			0.4	mA
Output Noise Voltage		$T_A = 25^{\circ}\text{C}$ , $10\text{ Hz} \leq f \leq 100\text{ kHz}$		300		$\mu\text{V}$
Ripple Rejection		$-25\text{ V} \leq V_{IN} \leq -15\text{ V}$ , $I_{OUT} = 100\text{ mA}$	50			dB
		$f = 120\text{ Hz}$ , $I_{OUT} = 300\text{ mA}$ , $T_J = 25^{\circ}\text{C}$	54	60		dB
Dropout Voltage		$T_J = 25^{\circ}\text{C}$		1.1		V
Short Circuit Current		$T_J = 25^{\circ}\text{C}$ , $V_{IN} = -30\text{ V}$			140	mA
Peak Output Current					650	mA
Average Temperature Coefficient of Output Voltage		$I_{OUT} = 5\text{ mA}$			-0.8	$\text{mV}/^{\circ}\text{C}$

\* $P_D \leq 4$  W

**NOTE:**

- All characteristics except noise voltage and ripple rejection ratio are measured using pulse techniques ( $t_w \leq 10$  ms, duty cycle  $\leq 5\%$ ). Output voltage changes due to changes in internal temperature must be taken into account separately.

# FAIRCHILD • $\mu$ A79M00 SERIES

## $\mu$ A79M15HM

**ELECTRICAL CHARACTERISTICS:**  $V_{IN} = -23$  V,  $I_{OUT} = 350$  mA,  $-55^{\circ}\text{C} \leq T_J \leq 125^{\circ}\text{C}$ ,  $C_{IN} = 2$   $\mu$ F,  $C_{OUT} = 1$   $\mu$ F, unless otherwise specified.

CHARACTERISTICS		CONDITIONS (Note 1)	MIN	TYP	MAX	UNITS
Output Voltage		$T_J = 25^{\circ}\text{C}$	-15.6	-15	-14.4	V
Line Regulation		$T_J = 25^{\circ}\text{C}$ $-30\text{ V} \leq V_{IN} \leq -17.5\text{ V}$		9.0	80	mV
		$-28\text{ V} \leq V_{IN} \leq -18\text{ V}$		7.0	50	mV
Load Regulation		$T_J = 25^{\circ}\text{C}$ , $5\text{ mA} \leq I_{OUT} \leq 500\text{ mA}$		65	240	mV
		$T_J = 25^{\circ}\text{C}$ , $5\text{ mA} \leq I_{OUT} \leq 350\text{ mA}$		45		mV
Output Voltage		$-30\text{ V} \leq V_{IN} \leq -17.5\text{ V}$ , $5\text{ mA} \leq I_{OUT} \leq 350\text{ mA}^*$	-15.75		-14.25	V
Quiescent Current		$T_J = 25^{\circ}\text{C}$		1.5	3.0	mA
Quiescent Current Change	with line	$-30\text{ V} \leq V_{IN} \leq -17.5\text{ V}$			0.4	mA
	with load	$5\text{ mA} \leq I_{OUT} \leq 350\text{ mA}$			0.4	mA
Output Noise Voltage		$T_A = 25^{\circ}\text{C}$ , $10\text{ Hz} \leq f \leq 100\text{ kHz}$		25	80	$\mu\text{V}/\text{V}_{OUT}$
Ripple Rejection		$-28.5\text{ V} \leq V_{IN} \leq -18.5\text{ V}$ , $I_{OUT} = 100\text{ mA}$	50			dB
		$f = 120\text{ Hz}$ , $I_{OUT} = 300\text{ mA}$ , $T_J = 25^{\circ}\text{C}$	54	59		dB
Dropout Voltage		$T_J = 25^{\circ}\text{C}$		1.1	2.3	V
Short Circuit Current		$T_J = 25^{\circ}\text{C}$ , $V_{IN} = -35\text{ V}$			0.6	A
Peak Output Current			0.4	0.65	1.4	A
Average Temperature Coefficient of Output Voltage		$I_{OUT} = 5\text{ mA}$ , $-55^{\circ}\text{C} \leq T_J \leq +150^{\circ}\text{C}$			0.3	$\text{mV}/^{\circ}\text{C}/\text{V}_{OUT}$

15.75  
15  
15.75

## $\mu$ A79M15AHC AND $\mu$ A79M15AUC

**ELECTRICAL CHARACTERISTICS:**  $V_{IN} = -23$  V,  $I_{OUT} = 350$  mA,  $-55^{\circ}\text{C} \leq T_J \leq 150^{\circ}\text{C}$ ,  $C_{IN} = 2$   $\mu$ F,  $C_{OUT} = 1$   $\mu$ F, unless otherwise specified.

CHARACTERISTICS		CONDITIONS (Note 1)	MIN	TYP	MAX	UNITS
Output Voltage		$T_J = 25^{\circ}\text{C}$	-15.6	-15	-14.4	V
Line Regulation		$T_J = 25^{\circ}\text{C}$ $-30\text{ V} \leq V_{IN} \leq -17.5\text{ V}$		9.0	80	mV
		$-28\text{ V} \leq V_{IN} \leq -18\text{ V}$		7.0	50	mV
Load Regulation		$T_J = 25^{\circ}\text{C}$ , $5\text{ mA} \leq I_{OUT} \leq 500\text{ mA}$		65	240	mV
		$T_J = 25^{\circ}\text{C}$ , $5\text{ mA} \leq I_{OUT} \leq 350\text{ mA}$		45		mV
Output Voltage		$-30\text{ V} \leq V_{IN} \leq -17.5\text{ V}$ , $5\text{ mA} \leq I_{OUT} \leq 350\text{ mA}$	-15.75		-14.25	V
Quiescent Current		$T_J = 25^{\circ}\text{C}$		1.5	3.0	mA
Quiescent Current Change	with line	$-30\text{ V} \leq V_{IN} \leq -17.5\text{ V}$			0.4	mA
	with load	$5\text{ mA} \leq I_{OUT} \leq 350\text{ mA}$			0.4	mA
Output Noise Voltage		$T_A = 25^{\circ}\text{C}$ , $10\text{ Hz} \leq f \leq 100\text{ kHz}$		375		$\mu\text{V}$
Ripple Rejection		$-28.5\text{ V} \leq V_{IN} \leq -18.5\text{ V}$ , $I_{OUT} = 100\text{ mA}$	50			dB
		$f = 120\text{ Hz}$ , $I_{OUT} = 300\text{ mA}$ , $T_J = 25^{\circ}\text{C}$	54	59		dB
Dropout Voltage		$T_J = 25^{\circ}\text{C}$		1.1		V
Short Circuit Current		$T_J = 25^{\circ}\text{C}$ , $V_{IN} = -30\text{ V}$		140		mA
Peak Output Current				650		mA
Average Temperature Coefficient of Output Voltage		$I_{OUT} = 5\text{ mA}$		-1.0		$\text{mV}/^{\circ}\text{C}$

\* $P_D \leq 4$  W

**NOTE:**

- All characteristics except noise voltage and ripple rejection ratio are measured using pulse techniques ( $t_w \leq 10$  ms, duty cycle  $\leq 5\%$ ). Output voltage changes due to changes in internal temperature must be taken into account separately.

# FAIRCHILD • $\mu$ A79M00 SERIES

## $\mu$ A79M20HM

**ELECTRICAL CHARACTERISTICS:**  $V_{IN} = -29$  V,  $I_{OUT} = 350$  mA,  $-55^{\circ}\text{C} \leq T_J \leq 150^{\circ}\text{C}$ ,  $C_{IN} = 2$   $\mu$ F,  $C_{OUT} = 1$   $\mu$ F unless otherwise specified.

CHARACTERISTICS		CONDITIONS (Note 1)	MIN	TYP	MAX	UNITS
Output Voltage		$T_J = 25^{\circ}\text{C}$	-20.8	-20	-19.2	V
Line Regulation		$T_J = 25^{\circ}\text{C}$ $-35\text{ V} < V_{IN} < -23\text{ V}$		12	80	mV
		$-34\text{ V} < V_{IN} < -24\text{ V}$		10	70	mV
Load Regulation		$T_J = 25^{\circ}\text{C}$ , $5\text{ mA} < I_{OUT} < 500\text{ mA}$		75	300	mV
		$T_J = 25^{\circ}\text{C}$ , $5\text{ mA} < I_{OUT} < 350\text{ mA}$		50		mV
Output Voltage		$-35\text{ V} < V_{IN} < -23\text{ V}$ , $5\text{ mA} < I_{OUT} < 350\text{ mA}^*$	-21		-19	V
Quiescent Current		$T_J = 25^{\circ}\text{C}$		1.5	3.5	mA
Quiescent Current Change		with line $-35\text{ V} < V_{IN} < -23\text{ V}$			0.4	mA
		with load $5\text{ mA} < I_{OUT} < 350\text{ mA}$			0.4	mA
Output Noise Voltage		$T_A = 25^{\circ}\text{C}$ , $10\text{ Hz} < f < 100\text{ kHz}$		25	80	$\mu\text{V}/V_{OUT}$
Ripple Rejection		$-34\text{ V} < V_{IN} < -24\text{ V}$ , $I_{OUT} = 100\text{ mA}$	50			dB
		$f = 120\text{ Hz}$ , $I_{OUT} = 300\text{ mA}$ , $T_J = 25^{\circ}\text{C}$	54	58		dB
Dropout Voltage		$T_J = 25^{\circ}\text{C}$		1.1	2.3	V
Short Circuit Current		$T_J = 25^{\circ}\text{C}$ , $V_{IN} = -35\text{ V}$			0.6	A
Peak Output Current			0.4	0.65	1.4	A
Average Temperature Coefficient of Output Voltage		$I_{OUT} = 5\text{ mA}$ , $-55^{\circ}\text{C} \leq T_J \leq +150^{\circ}\text{C}$			0.3	$\text{mV}/^{\circ}\text{C}$ $/V_{OUT}$

## $\mu$ A79M20AHC AND $\mu$ A79M20AUC

**ELECTRICAL CHARACTERISTICS:**  $V_{IN} = -29$  V,  $I_{OUT} = 350$  mA,  $0^{\circ}\text{C} \leq T_J \leq 125^{\circ}\text{C}$ ,  $C_{IN} = 2$   $\mu$ F,  $C_{OUT} = 1$   $\mu$ F, unless otherwise specified.

CHARACTERISTICS		CONDITIONS (Note 1)	MIN	TYP	MAX	UNITS
Output Voltage		$T_J = 25^{\circ}\text{C}$	-20.8	-20	-19.2	V
Line Regulation		$T_J = 25^{\circ}\text{C}$ $-35\text{ V} < V_{IN} < -23\text{ V}$		12	80	mV
		$-34\text{ V} < V_{IN} < -24\text{ V}$		10	70	mV
Load Regulation		$T_J = 25^{\circ}\text{C}$ , $5\text{ mA} < I_{OUT} < 500\text{ mA}$		75	300	mV
		$T_J = 25^{\circ}\text{C}$ , $5\text{ mA} < I_{OUT} < 350\text{ mA}$		50		mV
Output Voltage		$-35\text{ V} < V_{IN} < -23\text{ V}$ , $5\text{ mA} < I_{OUT} < 350\text{ mA}$	-21		-19	V
Quiescent Current		$T_J = 25^{\circ}\text{C}$		1.5	3.5	mA
Quiescent Current Change		with line $-35\text{ V} < V_{IN} < -23\text{ V}$			0.4	mA
		with load $5\text{ mA} < I_{OUT} < 350\text{ mA}$			0.4	mA
Output Noise Voltage		$T_A = 25^{\circ}\text{C}$ , $10\text{ Hz} < f < 100\text{ kHz}$		500		$\mu\text{V}$
Ripple Rejection		$-34\text{ V} < V_{IN} < -24\text{ V}$ , $I_{OUT} = 100\text{ mA}$	50			dB
		$f = 120\text{ Hz}$ , $I_{OUT} = 300\text{ mA}$ , $T_J = 25^{\circ}\text{C}$	54	58		dB
Dropout Voltage		$T_J = 25^{\circ}\text{C}$		1.1		V
Short Circuit Current		$T_J = 25^{\circ}\text{C}$ , $V_{IN} = -30$		140		mA
Peak Output Current				650		mA
Average Temperature Coefficient of Output Voltage		$I_{OUT} = 5\text{ mA}$			-1.0	$\text{mV}/^{\circ}\text{C}$

\* $P_D < 4\text{ W}$

**NOTE:**

1. All characteristics except noise voltage and ripple rejection ratio are measured using pulse techniques ( $t_w \leq 10$  ms, duty cycle  $\leq 5\%$ ). Output voltage changes due to changes in internal temperature must be taken into account separately.

# FAIRCHILD • $\mu$ A79M00 SERIES

## $\mu$ A79M24HM

**ELECTRICAL CHARACTERISTICS:**  $V_{IN} = -33$  V,  $I_{OUT} = 350$  mA,  $-55^{\circ}\text{C} \leq T_J \leq 150^{\circ}\text{C}$ ,  $C_{IN} = 2$   $\mu$ F,  $C_{OUT} = 1$   $\mu$ F, unless otherwise specified.

CHARACTERISTICS	CONDITIONS (Note 1)		MIN	TYP	MAX	UNITS
Output Voltage	$T_J = 25^{\circ}\text{C}$		-25	-24	-23	V
Line Regulation	$T_J = 25^{\circ}\text{C}$	$-38\text{ V} \leq V_{IN} \leq -27\text{ V}$		12	80	mV
		$-38\text{ V} \leq V_{IN} \leq -28\text{ V}$		12	70	mV
Load Regulation	$T_J = 25^{\circ}\text{C}$ , $5\text{ mA} \leq I_{OUT} \leq 500\text{ mA}$			75	300	mV
	$T_J = 25^{\circ}\text{C}$ , $5\text{ mA} \leq I_{OUT} \leq 350\text{ mA}$			50		mV
Output Voltage	$-38\text{ V} \leq V_{IN} \leq -27\text{ V}$ , $5\text{ mA} \leq I_{OUT} \leq 350\text{ mA}^*$		-25.2		-22.8	V
Quiescent Current	$T_J = 25^{\circ}\text{C}$			1.5	3.5	mA
Quiescent Current Change	with line	$-38\text{ V} \leq V_{IN} \leq -27\text{ V}$			0.4	mA
	with load	$5\text{ mA} \leq I_{OUT} \leq 350\text{ mA}$			0.4	mA
Output Noise Voltage	$T_A = 25^{\circ}\text{C}$ , $10\text{ Hz} \leq f \leq 100\text{ kHz}$			25	80	$\mu\text{V}/\sqrt{\text{V}_{OUT}}$
Ripple Rejection	$-38\text{ V} \leq V_{IN} \leq -28\text{ V}$ , $I_{OUT} = 100\text{ mA}$		50			dB
	$f = 120\text{ Hz}$ , $I_{OUT} = 300\text{ mA}$ , $T_J = 25^{\circ}\text{C}$		54	58		dB
Dropout Voltage	$T_J = 25^{\circ}\text{C}$			1.1	2.3	V
Short Circuit Current	$T_J = 25^{\circ}\text{C}$ , $V_{IN} = -35\text{ V}$				0.6	A
Peak Output Current			0.4	0.65	1.4	A
Average Temperature Coefficient of Output Voltage	$I_{OUT} = 5\text{ mA}$ , $-55^{\circ}\text{C} \leq T_J \leq +150^{\circ}\text{C}$				0.3	$\text{mV}/^{\circ}\text{C}$ $/V_{OUT}$

## $\mu$ A79M24AHC AND $\mu$ A79M24AUC

**ELECTRICAL CHARACTERISTICS:**  $V_{IN} = -33$  V,  $I_{OUT} = 350$  mA,  $0^{\circ}\text{C} \leq T_J \leq 125^{\circ}\text{C}$ ,  $C_{IN} = 2$   $\mu$ F,  $C_{OUT} = 1$   $\mu$ F, unless otherwise specified.

CHARACTERISTICS	CONDITIONS (Note 1)		MIN	TYP	MAX	UNITS
Output Voltage	$T_J = 25^{\circ}\text{C}$		-25	-24	-23	V
Line Regulation	$T_J = 25^{\circ}\text{C}$	$-38\text{ V} \leq V_{IN} \leq -27\text{ V}$		12	80	mV
		$-38\text{ V} \leq V_{IN} \leq -28\text{ V}$		12	70	mV
Load Regulation	$T_J = 25^{\circ}\text{C}$ , $5\text{ mA} \leq I_{OUT} \leq 500\text{ mA}$			75	300	mV
	$T_J = 25^{\circ}\text{C}$ , $5\text{ mA} \leq I_{OUT} \leq 350\text{ mA}$			50		mV
Output Voltage	$-38\text{ V} \leq V_{IN} \leq -27\text{ V}$ , $5\text{ mA} \leq I_{OUT} \leq 350\text{ mA}$		-25.2		-22.8	V
Quiescent Current	$T_J = 25^{\circ}\text{C}$			1.5	3.5	mA
Quiescent Current Change	with line	$-38\text{ V} \leq V_{IN} \leq -27\text{ V}$			0.4	mA
	with load	$5\text{ mA} \leq I_{OUT} \leq 350\text{ mA}$			0.4	mA
Output Noise Voltage	$T_A = 25^{\circ}\text{C}$ , $10\text{ Hz} \leq f \leq 100\text{ kHz}$			600		$\mu\text{V}$
Ripple Rejection	$-38\text{ V} \leq V_{IN} \leq -28\text{ V}$ , $I_{OUT} = 100\text{ mA}$		50			dB
	$f = 120\text{ Hz}$ , $I_{OUT} = 300\text{ mA}$ , $T_J = 25^{\circ}\text{C}$		54	58		dB
Dropout Voltage	$T_J = 25^{\circ}\text{C}$			1.1		V
Short Circuit Current	$T_J = 25^{\circ}\text{C}$ , $V_{IN} = -30\text{ V}$			140		mA
Peak Output Current				650		mA
Average Temperature Coefficient of Output Voltage	$I_{OUT} = 5\text{ mA}$			-1.0		$\text{mV}/^{\circ}\text{C}$

\* $P_D \leq 4$  W

**NOTE:**

- All characteristics except noise voltage and ripple rejection ratio are measured using pulse techniques ( $t_w \leq 10$  ms, duty cycle  $\leq 5\%$ ). Output voltage changes due to changes in internal temperature must be taken into account separately.

### DC PARAMETER TEST CIRCUIT

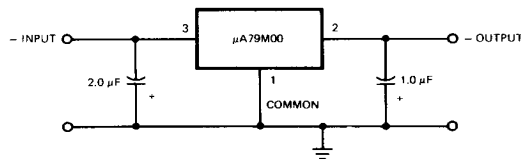



**DESIGN CONSIDERATIONS**

The  $\mu$ A79M00 fixed voltage regulator series has thermal overload protection from excessive power, internal short circuit protection which limits the circuit's maximum current, and output transistor safe area compensation for reducing the output current as the voltage across the pass transistor is increased.

The safe area protection network may cause the device to latch-up if the output is shorted and the regulator is operating with high input voltages. This mode of operation will not damage the device. However, power (input voltage or the load) must be interrupted momentarily for the device to recover from the latched condition.

Although the internal power dissipation is limited, the junction temperature must be kept below the maximum specified temperature (150°C for 79M00, 125°C for 79M00AC and 79M00C) in order to meet data sheet specifications. To calculate the maximum junction temperature or heat sink required, the following thermal resistance values should be used:

PACKAGE	TYP	MAX	TYP	MAX
	$\theta_{JC}$	$\theta_{JC}$	$\theta_{JA}$	$\theta_{JA}$
TO-39	18.0	25	120	185
TO-220	3.0	5.0	62	70

$$P_D (\text{MAX}) = \frac{T_J (\text{MAX}) - T_A}{\theta_{JC} + \theta_{CA}} \text{ or } \frac{T_J (\text{MAX}) - T_A}{\theta_{JA}} \text{ (Without a heat sink)}$$

$$\theta_{CA} = \theta_{CS} + \theta_{SA}$$

$$\text{Solving for } T_J: T_J = T_A + P_D(\theta_{JC} + \theta_{CA}) \text{ or } T_A + P_D \theta_{JA} \text{ (Without a heat sink)}$$

Where  $T_J$  = Junction Temperature

$T_A$  = Ambient Temperature

$P_D$  = Power Dissipation

$\theta_{JC}$  = Junction to case thermal resistance

$\theta_{CA}$  = Case to ambient thermal resistance

$\theta_{CS}$  = Case to heat sink thermal resistance

$\theta_{SA}$  = Heat sink to ambient thermal resistance

$\theta_{JA}$  = Junction to ambient thermal resistance

**WORST CASE POWER DISSIPATION  
VERSUS AMBIENT TEMPERATURE  
TO-39**

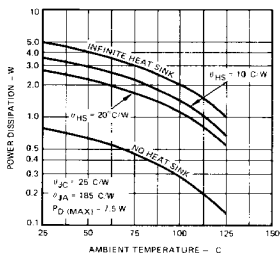

**WORST CASE POWER DISSIPATION  
VERSUS AMBIENT TEMPERATURE  
TO-220**

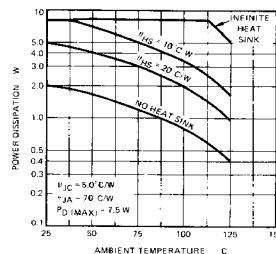

TYPICAL PERFORMANCE CURVES

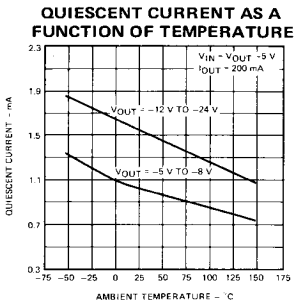
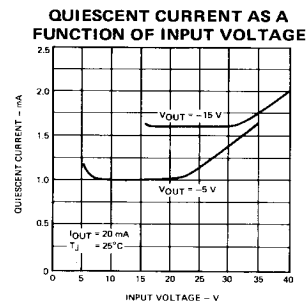
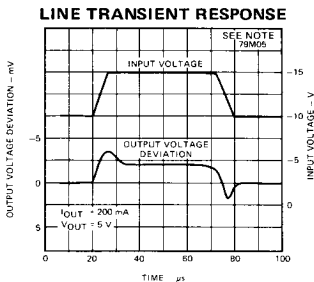
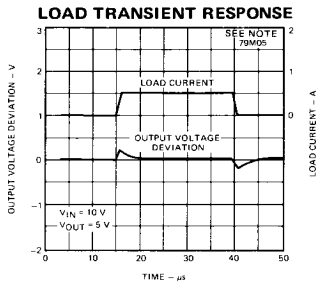
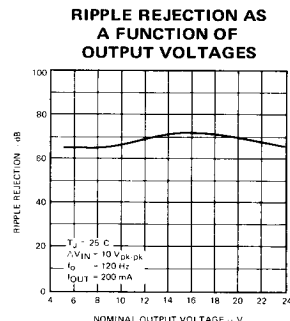
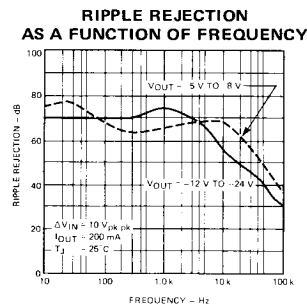
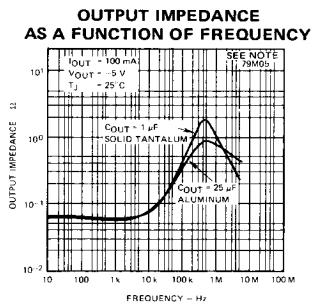
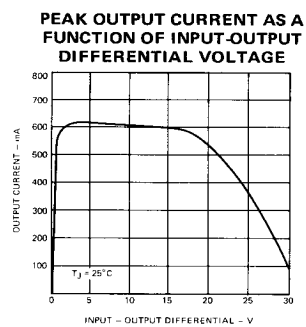
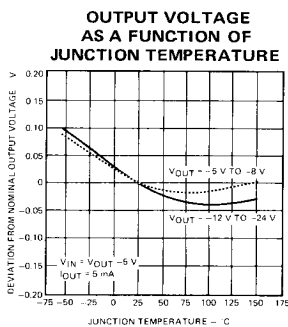
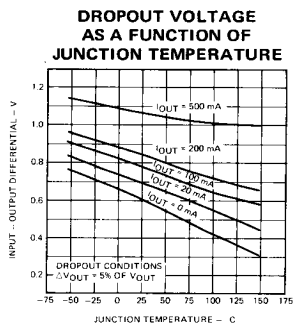

NOTE: The other  $\mu$ A79M00 voltage series devices have similar performance curves.

TYPICAL APPLICATIONS

Bypass capacitors are recommended for stable operation of the 79M00 series of regulators over the input voltage and output current ranges. Output bypass capacitors will improve the transient response of the regulator.

The bypass capacitors, (2  $\mu$ F on the input, 1  $\mu$ F on the output) should be ceramic or solid tantalum which have good high frequency characteristics. If aluminum electrolytics are used, their values should be 10  $\mu$ F or larger. The bypass capacitors should be mounted with the shortest leads, and if possible, directly across the regulator terminals.

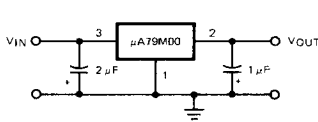

FIXED OUTPUT REGULATOR

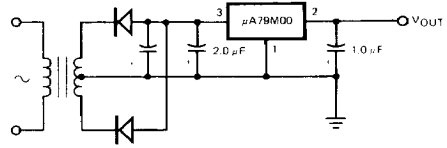

NEGATIVE OUTPUT VOLTAGE CIRCUIT

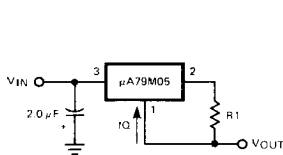

$$\text{OUTPUT CURRENT} = \frac{5.0 \text{ V}}{R_1} + I_Q$$

BASIC CURRENT REGULATOR

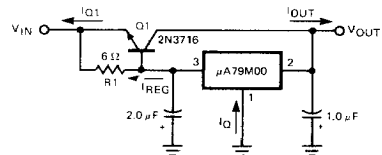

$$R_1 = \frac{V_{BE}(Q1)}{I_{REG}} = \frac{\beta V_{BE}(Q1)}{I_{REQ(MAX)} (\beta + 1) - I_{OUT(MAX)}}$$

$$I_{Q1} = \beta(Q1) I_{REG}$$

HIGH CURRENT VOLTAGE REGULATOR

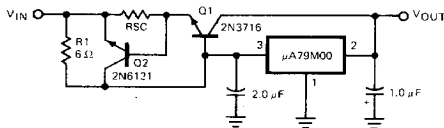

$$R_1 = \frac{\beta V_{BE}(Q1)}{I_{REQ(MAX)} (\beta + 1) - I_{OUT(MAX)}}$$

$$R_{SC} = \frac{V_{BE}(Q2)}{I_{SC}}$$

HIGH OUTPUT CURRENT, SHORT CIRCUIT PROTECTED

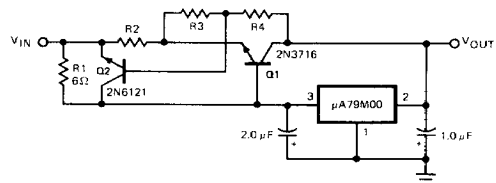

$$R_1 = \frac{\beta V_{BE}(Q1)}{I_{REQ(MAX)} (\beta + 1) - I_{OUT(MAX)}}$$

HIGH OUTPUT CURRENT, FOLDBACK CURRENT LIMITED

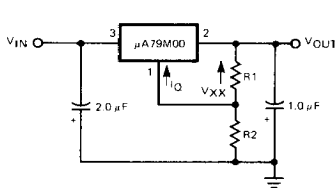

$$|V_{OUT}| = V_{XX} \left( 1 + \frac{R_2}{R_1} \right) + I_Q R_2$$

VARIABLE OUTPUT VOLTAGE REGULATOR

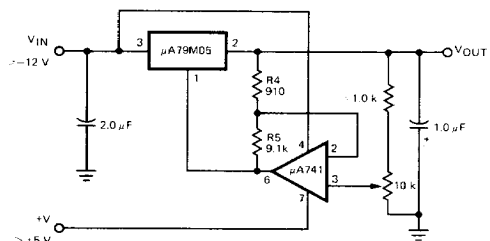

VARIABLE OUTPUT VOLTAGE, -0.5 V TO -10 V

TYPICAL APPLICATIONS (Cont'd)

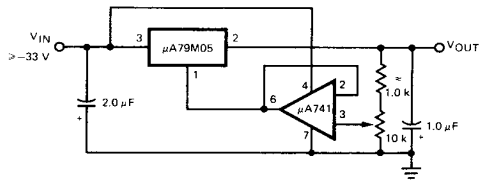

VARIABLE OUTPUT VOLTAGE, -30 V TO -7 V

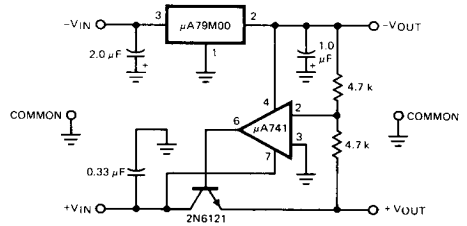

POSITIVE AND NEGATIVE TRACKING VOLTAGE REGULATOR