

1 2 3 4 5 6 7 8

A  
B  
C  
D  
E  
F  
G  
H

A  
B  
C  
D  
E  
F  
G  
H

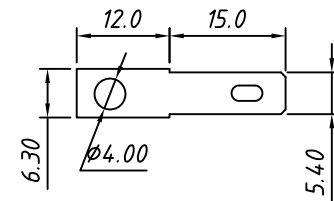
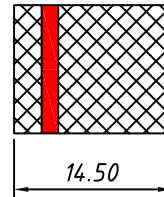
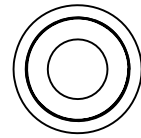
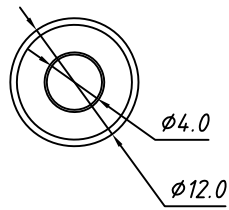

Accessories-5

Accessories-4

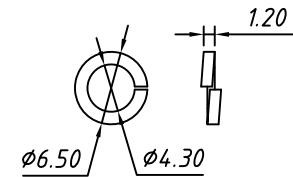
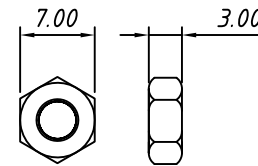
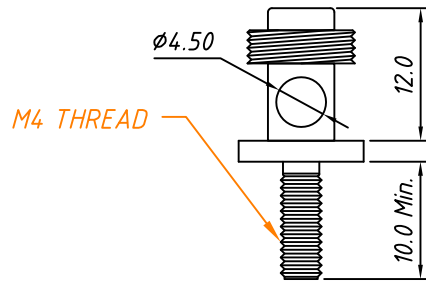
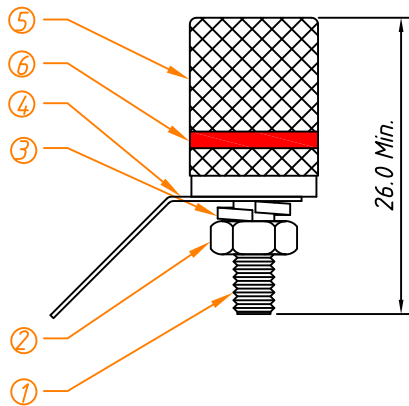

Accessories-1

Accessories-2

Accessories-3

Order Information

L-KLS1- BIP - 011-G-X

Color: R-Red  
B-Black

Binding Post

RoHS

6	Color Tag	Rubber	PCS	1
5	Block Shot	Zinc,Gold plated	PCS	1
4	Solder Terminal	27x6.3x0.4mm STEEL,Gold plated	PCS	1
3	Spring Washer	6.6x4.3x1.2mm STEEL,Gold plated	PCS	1
2	NUT	Nut,M4,Gold plated	PCS	1
1	Screw Body	Zinc,Gold plated	PCS	1
ITEM	PART NAME	Description	UNIT	Q'TY

		Description:	
		Binding Post Terminal	
PROJECTION		KLS P/N:	KLS1-BIP-011-G-X
UNITS	mm		
SHEET SIZE	A4		
Draw:Daniel	2019-07-18		NingBo KLS ELECTRONIC CO.,L TD.
Check:Daniel	2019-07-18		

1 2 3 4 5 6 7 8