

Features

Printed circuit mount 10 A relay

- 1 Pole changeover contacts or 1 Pole normally open contact
- Miniature - "Sugar cube" package
- DC coil - 360 mW
- Wash tight: RT III
- Cadmium Free contact material option

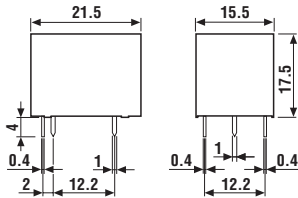

36.11

36.11-0300



- 1 CO (SPDT), 10 A
- Sugar cube size
- PCB mount

- 1 NO (SPST-NO), 10 A
- Sugar cube size
- PCB mount

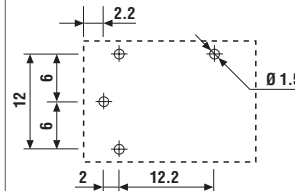
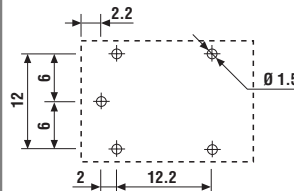
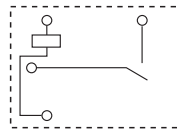
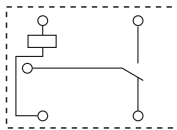

Copper side view

Copper side view

Contact specification			
Contact configuration		1 CO (SPDT)	1 NO (SPST-NO)
Rated current/Maximum peak current	A	10/15	10/15
Rated voltage/Maximum switching voltage V AC		250/250	250/250
Rated load AC1	VA	2,500	2,500
Rated load AC15 (230 V AC)	VA	500	500
Single phase motor rating (230 V AC)	kW	0.37	0.37
Breaking capacity DC1: 30/110/220 V	A	10/0.3/0.12	10/0.3/0.12
Minimum switching load	mW (V/mA)	500 (5/100)	500 (5/100)
Standard contact material		AgCdO	AgCdO
Coil specification			
Nominal voltage (U _N)	V AC (50/60 Hz)	—	—
	V DC	3 - 5 - 6 - 9 - 12 - 24 - 48	3 - 5 - 6 - 9 - 12 - 24 - 48
Rated power AC/DC	VA (50 Hz)/W	—/0.36	—/0.36
Operating range	AC	—	—
	DC	(0.75...1.5)U _N	(0.75...1.5)U _N
Holding voltage	AC/DC	—/0.4 U _N	—/0.4 U _N
Must drop-out voltage	AC/DC	—/0.1 U _N	—/0.1 U _N
Technical data			
Mechanical life AC/DC	cycles	—/10 · 10 ⁶	—/10 · 10 ⁶
Electrical life at rated load AC1	cycles	100 · 10 ³	100 · 10 ³
Operate/release time	ms	7/3	7/2
Insulation between coil and contacts (1.2/50 μs)	kV	4	4
Dielectric strength between open contacts V AC		1,000	1,000
Ambient temperature range	°C	−40...+85	−40...+85
Environmental protection		RT III	RT III
Approvals (according to type)			

Ordering information

Example: 36 series miniature PCB relay, 1 CO (SPDT) - 10 A contacts, 12 V DC coil.

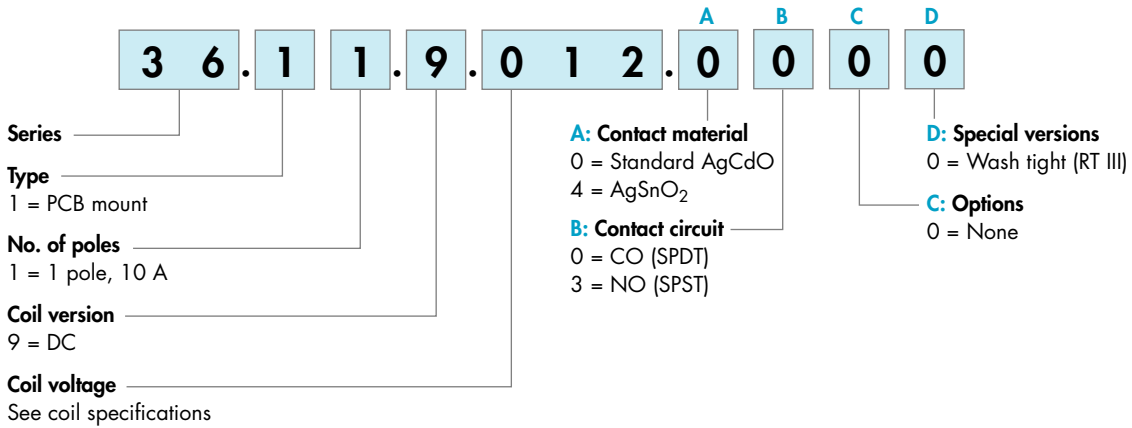

Selecting features and options: only combinations in the same row are possible.

Preferred selections for best availability are shown in **bold**.

Type	Coil version	A	B	C	D
36.11	DC	0 - 4	0 - 3	0	0

Technical data

Insulation			
Insulation according to EN 61810-1	insulation rated voltage	V	250
	rated impulse withstand voltage	kV	2.5
	pollution degree		2
	overvoltage category		II
Insulation between coil and contacts (1.2/50 µs)	kV		4
Dielectric strength between open contacts	V AC		1,000
Other data			
Bounce time: NO/NC	ms	1/6 (changeover)	1/— (normally open)
Vibration resistance (5...55)Hz, max. ± 1 mm: NO/NC	g	15/15 (changeover)	15/— (normally open)
Shock resistance	g	16	
Power lost to the environment	without contact current	W	0.4
	with rated current	W	1.4
Recommended distance between relays mounted on PCB	mm	≥ 5	

Contact specification

F 36 - Electrical life (AC) v contact current

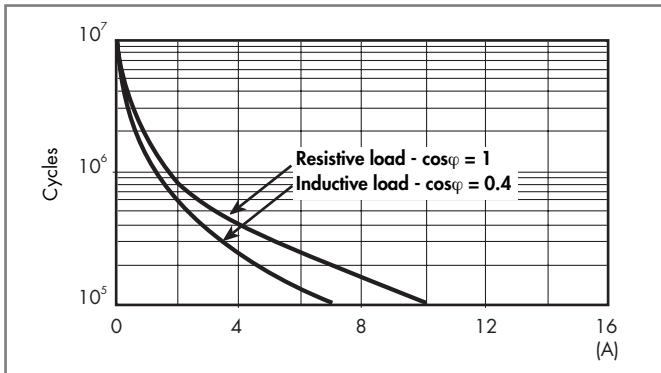

H 36 - Maximum DC1 breaking capacity

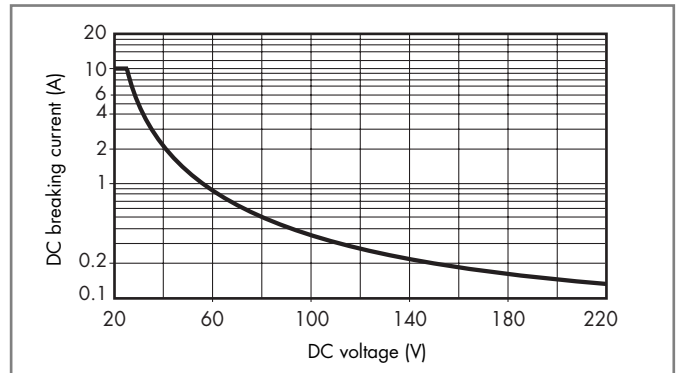

- When switching a resistive load (DC1) having voltage and current values under the curve, an electrical life of $\geq 100 \cdot 10^3$ can be expected.
- In the case of DC13 loads, the connection of a diode in parallel with the load will permit a similar electrical life as for a DC1 load. Note: the release time for the load will be increased.

Coil specifications

DC coil data

Nominal voltage U_N	Coil code	Operating range		Resistance R	Rated coil consumption I at U_N
		U_{min}	U_{max}		
V		V	V	Ω	mA
3	9.003	2.2	4.5	25	120
5	9.005	3.7	7.5	70	72
6	9.006	4.5	9	100	60
9	9.009	6.7	13.5	225	40
12	9.012	9	18	400	30
24	9.024	18	36	1,600	15
48	9.048	36	72	6,400	7.5

R 36 - DC coil operating range v ambient temperature

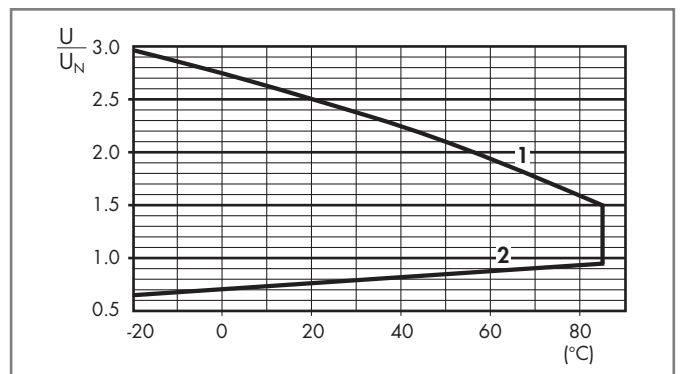

- 1 - Max. permitted coil voltage.
- 2 - Min. pick-up voltage with coil at ambient temperature.