

## FEATURES

- Carbon resistive element.
- Dust proof enclosure.
- Polyester substrate.
- Also upon request:
  - Wiper positioned at 50% or fully clockwise.
  - Long life model for low cost control pot. applications
  - Low torque option
  - Supplied in magazines for automatic insertion.
  - Self extinguishable plastic UL 94V-0
  - Cut track option
  - Special Tapers
  - Mechanical detents

## MECHANICAL SPECIFICATIONS

- Mechanical rotation angle:  $265^\circ \pm 5^\circ$   
 $240^\circ \pm 5^\circ$  available under drawing (blue housing only)
- Electrical rotation angle:  $240^\circ \pm 20^\circ$
- Torque: 0.5 to 2.5 Ncm.  
(0.7 to 3.4 in-oz)
- Stop torque:  $> 10$  Ncm. ( $> 14$  in-oz)
- Life: up to 200K cycles

## ELECTRICAL SPECIFICATIONS

- Range of values (\*)  
 $100\Omega \leq R_n \leq 5\text{ M}$  (Decad. 1.0 - 2.0 - 2.2 - 2.5 - 4.7 - 5.0)
- Tolerance (\*):  $100\Omega \leq R_n \leq 1\text{M}\Omega$  .....  $\pm 20\%$   
 $1\text{M}\Omega < R_n \leq 5\text{M}$  .....  $\pm 30\%$
- Max. Voltage: 250 VDC (lin) 125 VDC (no lin)
- Nominal Power  $50^\circ\text{C}$  ( $122^\circ\text{F}$ ) (see power rating curve)  
0.25 W (lin) 0.12 W (no lin)
- Taper (\*) (Log. & Alog. only  $R_n \geq 1\text{K}$ ) Lin ; Log; Alog.
- Residual resistance(\*):  $\leq 0.5\%$   $R_n$  ( $5\Omega$  min.)
- Equivalent Noise Resistance:  $\leq 3\%$   $R_n$  ( $3\Omega$  min.)
- Operating temperature\*\*:  $-25^\circ\text{C} + 70^\circ\text{C}$  ( $-13^\circ\text{F} + 158^\circ\text{F}$ )

\* Others upon request

\*\* Up to  $85^\circ\text{C}$  depending on application

## HOW TO ORDER

Series	Code	Mounting Method	Taper	Life	Detent	Flammability	Wiper position	Optional Extras	Shaft/rotor colour	Magazine	Torque
PT-15	H01	H2.5	A = Lin. B = Log. C = Alog.	E = Long life U = Extra Long life (See note 5)	See PT's with detents data sheet	I = non flammable (See note 6)	PM = 50% PF = Final	[ ] [ ] [ ] [ ] [ ] [ ] [ ] [ ] [ ] [ ]	RO=Red NE=Black VE=Green AM=Yellow AZ=Blue MA=Brown GR=Grey NA=Orange CR=Cream	T (See note 9)	- = Standard L = Low torque (See note 8)
Rotors	H05	H5									
	H25	HC5									
	H06	B									
	H02	H2.5P									
	H10	H5P									
	V02	V12.5									
	V12	VA									
	V15	V15									
	V17	V17.5									
	V18	D									
	V24	VD15									
	V21	V12.5P									
	V22	VAP									
	V23	V15P									
			Value	Tolerance	Cut track	Shaft Thum.					
			101 = 100 $\Omega$	2020 = $\pm 20\%$	PCI = Initial PCF = Final	01 - Fig. 1 : : 28 - Fig. 28					
			223 = 22 K	3030 = $\pm 30\%$ (See note 4)							
			504 = 500 K								
			505 = 5 M								

### NOTES:

- "Z" adjustment only available on "H" versions. Standard colour for the "T" rotor: Orange
- Terminal styles: "P" are crimped terminals. V=Vertical adjust; H=Horizontal Adjust
- Value Example: Code: 10 1 100  $\Omega$   
 ↳ Num of zeros  
 ↳ First two digits of the value.
- Non standard tolerance, upon request. Example: +7%      Code: 07 05  
 -5%      ↳ negative tolerance  
 ↳ positive tolerance
- Life
  - Standard 500 cycles
  - Long life 10000 cycles
  - Extra Long life 100000 cycles (to be studied case by case)
- Non flammable: housing, rotor and shaft. According to UL 94V-0
- Colour shaft/rotor:
  - Potentiometer without shaft: only rotor
  - Potentiometer with shaft: only shaft
 Cream colour only available in standard plastic
- Low Torque:  $\leq 1.5\text{Ncm}$ . No detent option available for low torque models
- Magazines (35 pcs/mag): available for VA (12.5), V (12.5), V (12.5P), V (15), V15 (P) and H models.  
For more information please contact your nearest Piher supplier.
- If you wish to use your own custom plastic shaft/knob/actuator please contact Piher for advice about compatible materials.

NOTE: The information contained here should be used for reference purposes only.

## HOW TO ORDER CUSTOM DRAWING

PT-15 LH 01 + DRAWING NUMBER (Max. 16 digits)

This way of ordering should be used for options which are not included in the "How to order" standard and optional extras.

## STANDARD OPTIONS

Mechanical Life .....	500 cycles
Cut track .....	No
Detents .....	None
Non flammable .....	No
Rotor colour .....	White
Shaft colour .....	Natural
Wiper position .....	Initial
Torque .....	Standard

## ROTORS

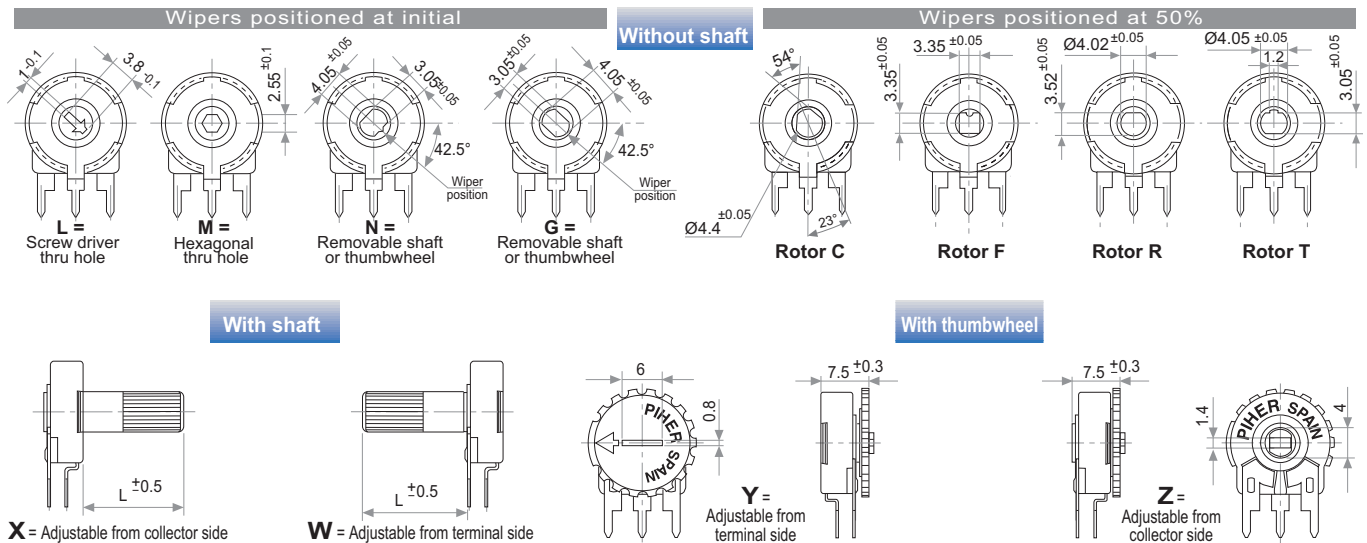

## VERTICAL MOUNT - HORIZONTAL ADJUST

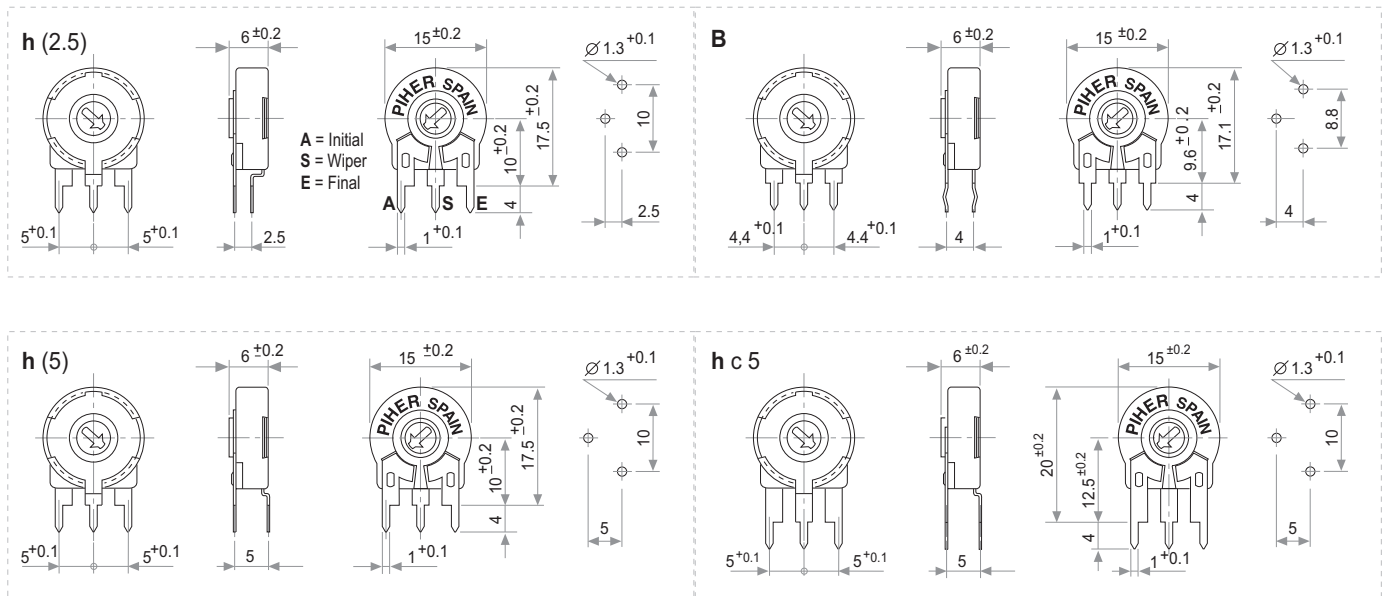

## HORIZONTAL MOUNT - VERTICAL ADJUST

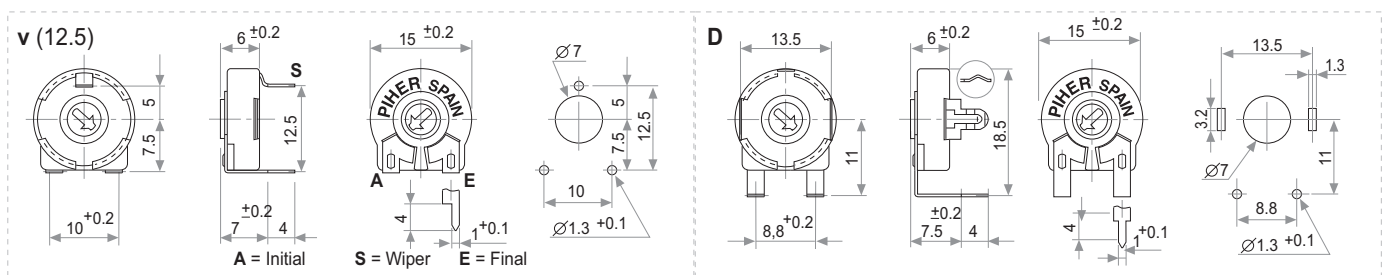

## HORIZONTAL MOUNT - VERTICAL ADJUST

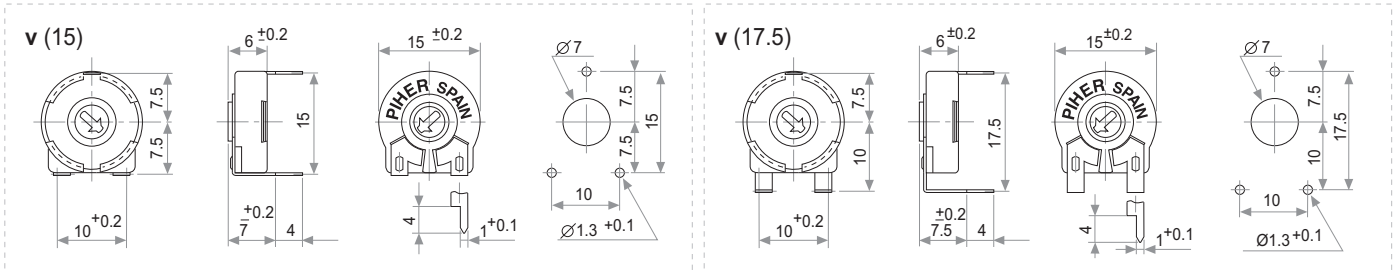
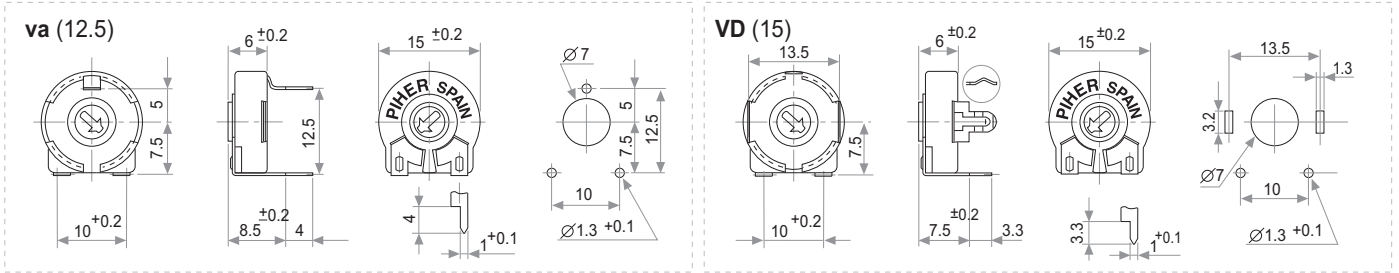

## CRIMPED TERMINALS (DETAIL)

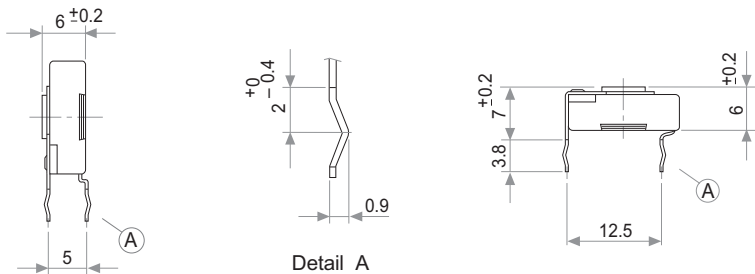

## POWER RATING CURVE

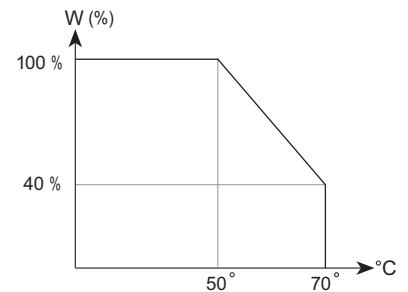

## TAPERS

NOTE: Please note terminals disposition when ordering non linear curves.

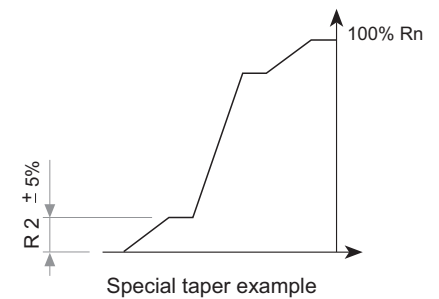
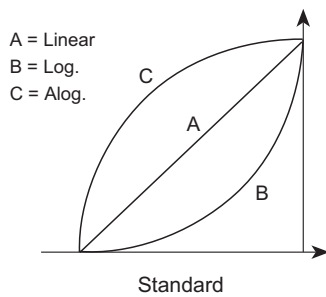

## OPTIONS

### Positioning

P.M.

50% ±20°



Std. Position = CCW

Cut Track

CCW on-off (A)

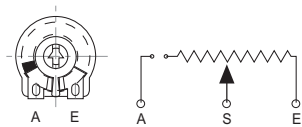

A = Initial  
S = Wiper  
E = Final

CW on-off (E)

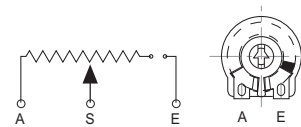

## TESTS

## TYPICAL VARIATIONS

ELECTRICAL LIFE	1.000 h. @ 50°C; 0.25 W	±5 %
MECHANICAL LIFE (CYCLES)	500 @ 10 CPM ...15 CPM	±3 % (Rn < 1 MΩ)
TEMPERATURE COEFFICIENT	-25°C; +70°C	±300 ppm (Rn <100 K)
THERMAL CYCLING	16 h. @ 85°C; 2h. @ 25°C	±2.5 %
DAMP HEAT	500 h. @ 40°C @ 95% HR	±5 %
VIBRATION (for each plane X,Y,Z)	2 h. @ 10 Hz. ... 55 Hz.	±2 %

NOTE : Out of range values may not comply these results.

## SHAFTS

### Hollow model shafts

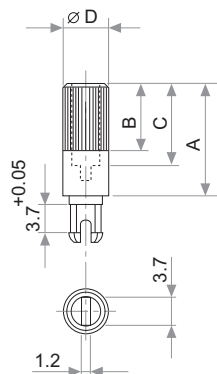

A = Length (FRS)  
 B = Knurling length  
 C = Hollow depth  
 D = Shaft diameter  
 FRS = From rotor surface

FIG.	A	B	C	D	Ref.
1	12	9	8	6	5272
2	19	9	15	6	5214
5	9.5	6.5	5.5	6	5208
9	35	9	31	6	5216
10	37.8	9	33.8	6	5218
11	35	25	15	6	5209
13	7.8	4.8	3.8	6	5265

### Solid model shafts

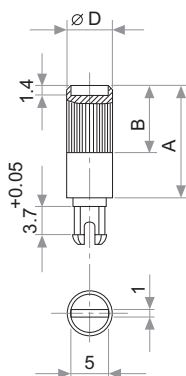

FIG.	A	B	D	Ref.
6	15	9	6	5219
7	16.8	9	6	5220
8	25.3	9	6	5207
12	46	5	6	5227

Slot (1 x 1.4) perpendicular to wiper position. Fig. 12 slot is on line with wiper position.

# SHAFTS

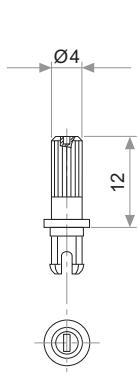

Fig. 3 / Ref. 5372

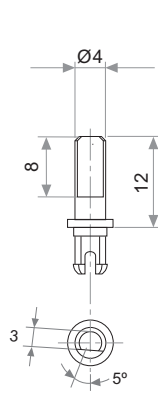

Fig. 15 / Ref. 5217

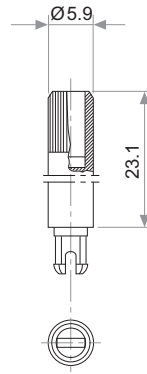

Fig. 17 / Ref. 5210

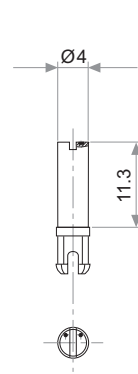

Fig. 18 / Ref. 5271

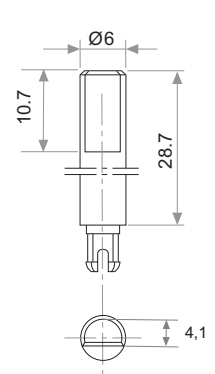

Fig. 19 / Ref. 6032\*

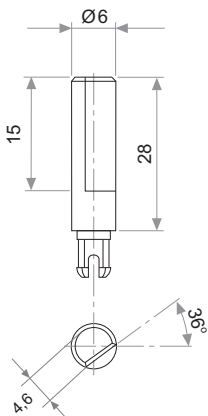

Fig. 20 / Ref. 5369\*

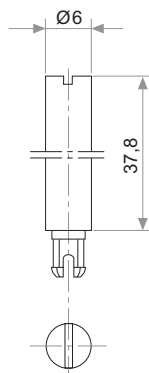

Fig. 21 / Ref. 6031\*

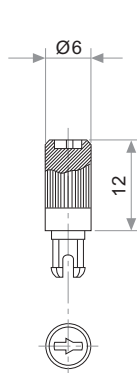

Fig. 22 / Ref. 6029

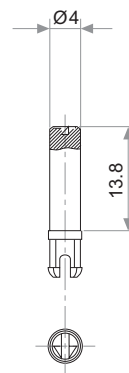

Fig. 23 / Ref. 6022

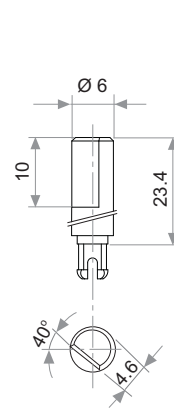

Fig. 29 / Ref. 6162

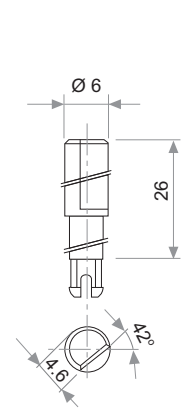

Fig. 25 / Ref. 6059

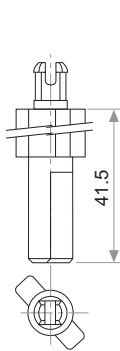

Fig. 27 / Ref. 5268\*

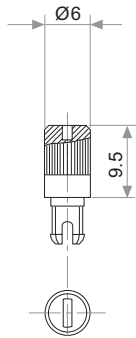

Fig. 28 / Ref. 6055

\* Not available in self extinguishable plastic

# THUMBWHEEL

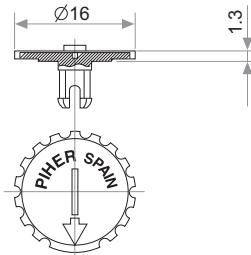

Fig. 4 / Ref. 5371