



LA4282

2-Channel 10 W AF Power Amplifier for Use in Home Stereo, TV Applications

Overview

The LA4282 is an IC which seals a high-output power amplifier for TVs and monitors in a compact package.

Features

- High-power 2-channel AF power amplifier
- Low distortion
- Minimum number of external parts required (no bootstrap capacitor required)
- Low pop noise at the time of power supply ON/OFF
- Good ripple rejection (58 dB typ)
- Wide operating voltage range
- External muting available
- On-chip protector against abnormality (thermal shutdown, overvoltage)

Package Dimensions

unit : mm

3049A-SIP12H

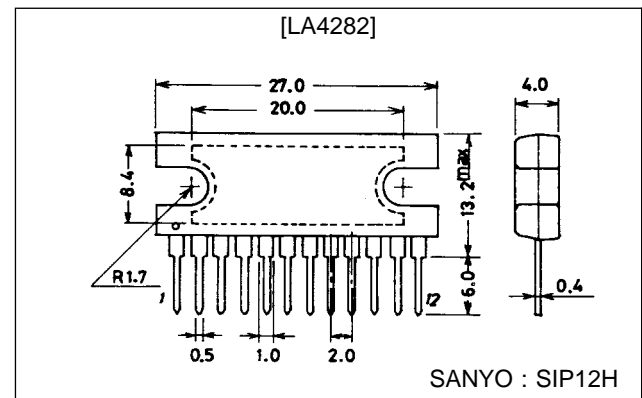

Specifications

Maximum Ratings at $T_a = 25\text{ }^\circ\text{C}$

Parameter	Symbol	Conditions	Ratings	Unit
Maximum supply voltage	$V_{CC\text{ max}}$	Quiescent	45	V
Maximum output current	$I_{O\text{ peak}}$		4	A
Allowable power dissipation	$P_d\text{ max}$	With heat sink	25	W
Operating temperature	T_{opr}		-20 to +75	$^\circ\text{C}$
Storage temperature	T_{stg}		-40 to +150	$^\circ\text{C}$

Operating Conditions at $T_a = 25\text{ }^\circ\text{C}$

Parameter	Symbol	Conditions	Ratings	Unit
Recommended supply voltage	V_{CC}		32	V
	$V_{CC\text{ op}}$		10 to 40	V
Recommended load resistance	R_L		8	Ω

■ Any and all SANYO products described or contained herein do not have specifications that can handle applications that require extremely high levels of reliability, such as life-support systems, aircraft's control systems, or other applications whose failure can be reasonably expected to result in serious physical and/or material damage. Consult with your SANYO representative nearest you before using any SANYO products described or contained herein in such applications.

■ SANYO assumes no responsibility for equipment failures that result from using products at values that exceed, even momentarily, rated values (such as maximum ratings, operating condition ranges, or other parameters) listed in products specifications of any and all SANYO products described or contained herein.

LA4282

**Operating Characteristics at $T_a = 25^\circ\text{C}$, $V_{CC} = 32\text{ V}$, $R_L = 8\ \Omega$, $f = 1\text{ kHz}$, $R_g = 600\ \Omega$,
See Test Circuit.**

Parameter	Symbol	Conditions	min	typ	max	Unit
Quiescent current	$I_{CCO(1)}$	Quiescent	30	60	100	mA
	$I_{CCO(2)}$	Muting switch On	30	56	100	mA
Voltage gain	VG		38	40	42	dB
Voltage gain difference	ΔVG				1.5	dB
Output power	$P_O(1)$	THD = 1%	9.0	10.0		W
	$P_O(2)$	THD = 3%	10.0	11.5		W
Total harmonic distortion	THD	$P_O = 2\text{ W}$		0.05	0.20	%
Output noise voltage	V_{NO}	$R_g = 10\text{ k}\Omega$, BW = 20 Hz to 20 kHz		0.25	1.0	mV
Ripple rejection	SVRR	$R_g = 10\text{ k}\Omega$, $f_R = 100\text{ Hz}$, $V_R = 0\text{ dBm}$	45	58		dB
Crosstalk	CT	$R_g = 10\text{ k}\Omega$	45	60		dB
Muting	$V_{O(MT)}$	Muting switch On, $V_{IN} = -5\text{ dBm}$			-35	dBm

Equivalent Circuit Block Diagram and Pin Assignment

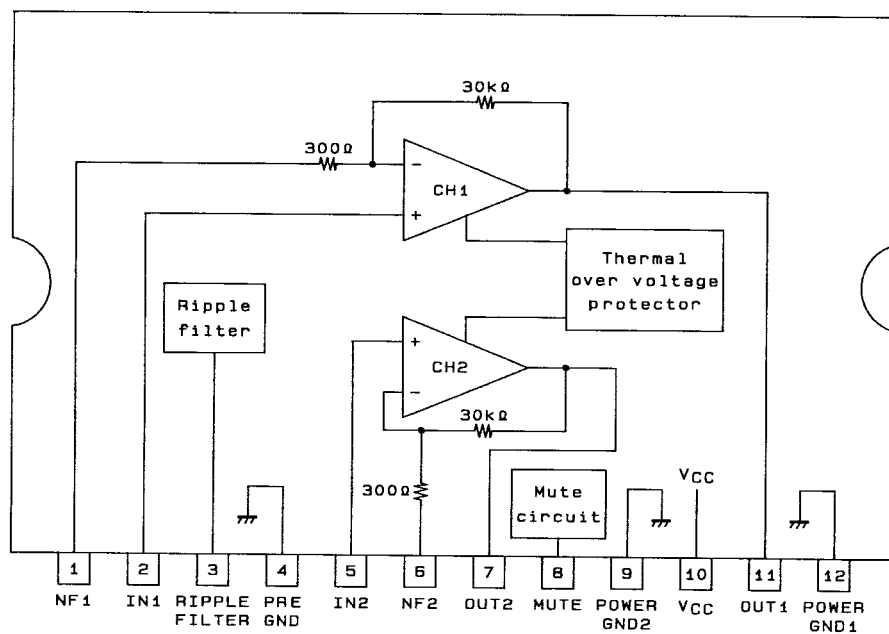

A05005

LA4282

Test Circuit

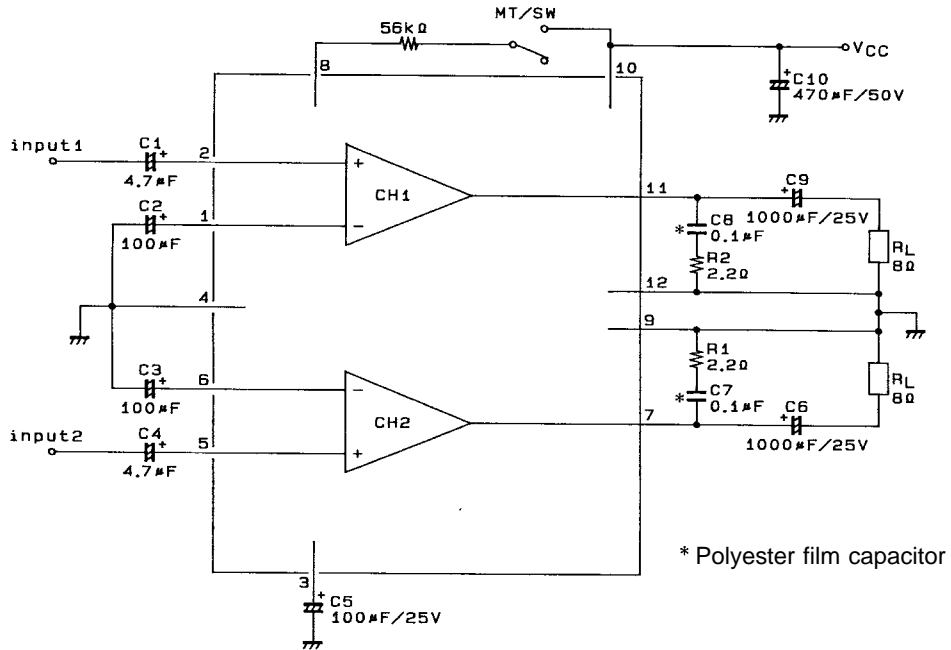

A05006

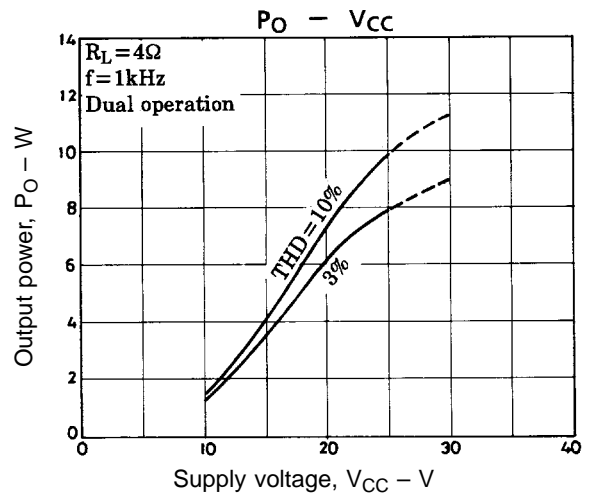
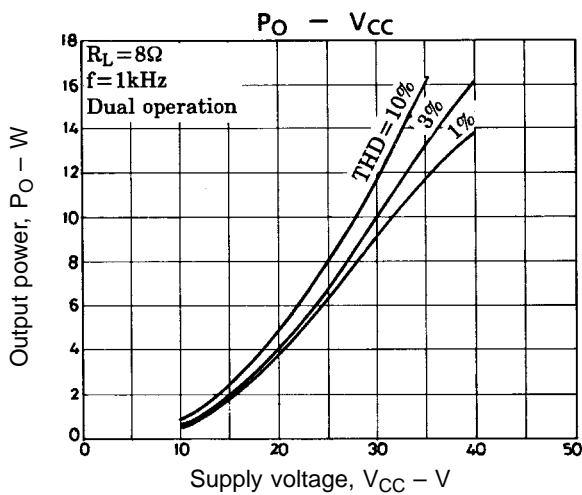
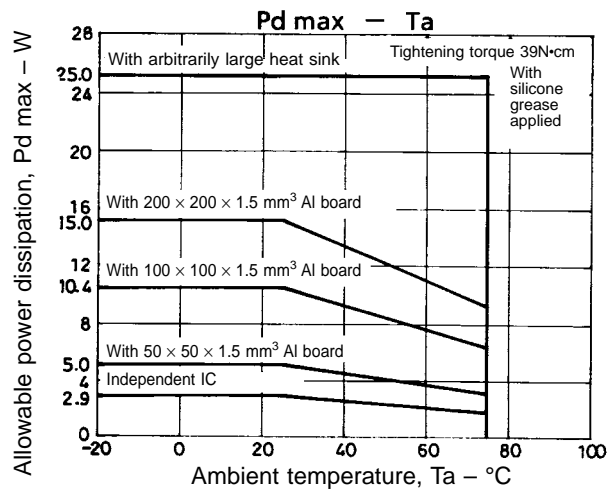

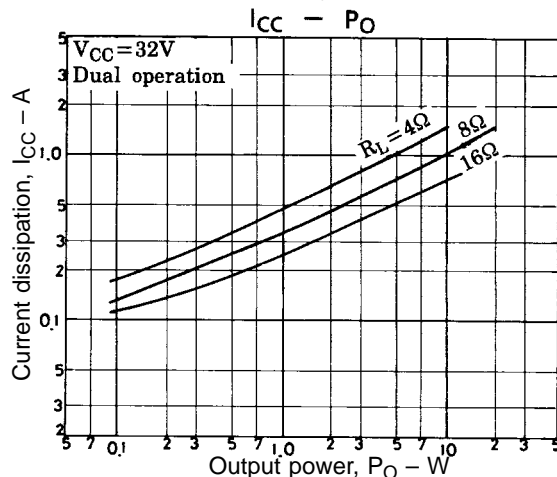
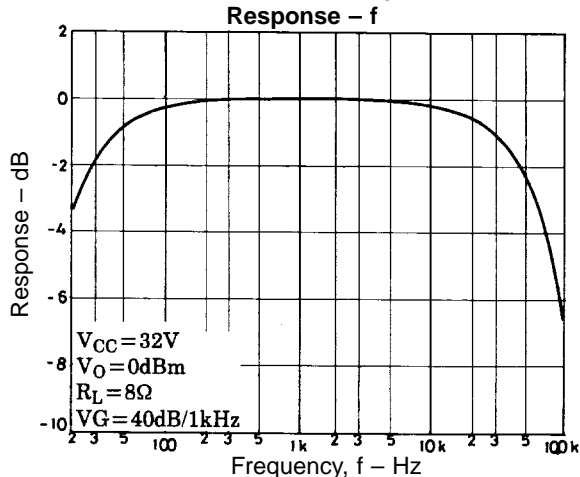
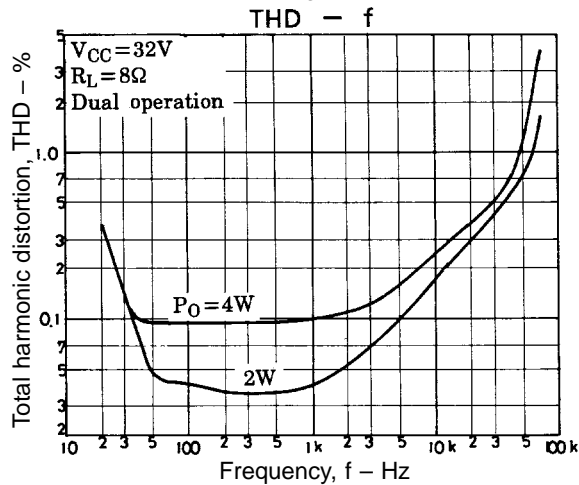
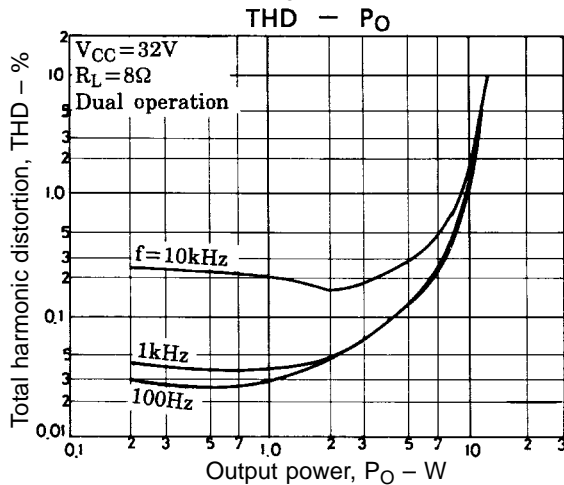
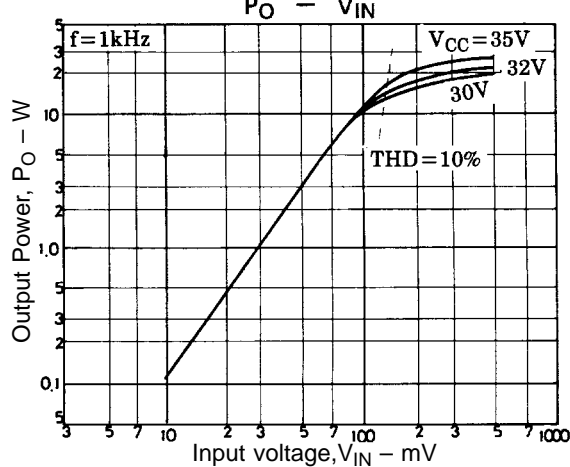
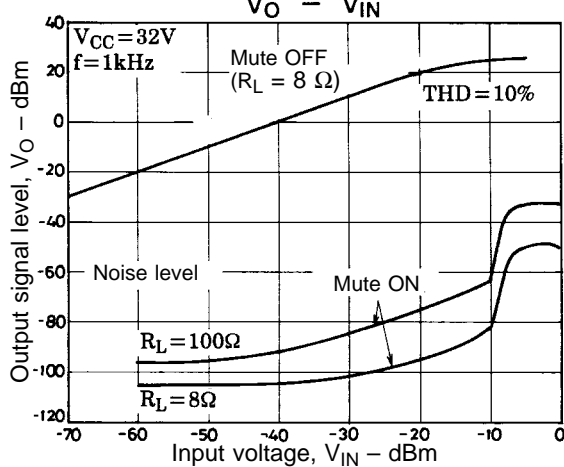
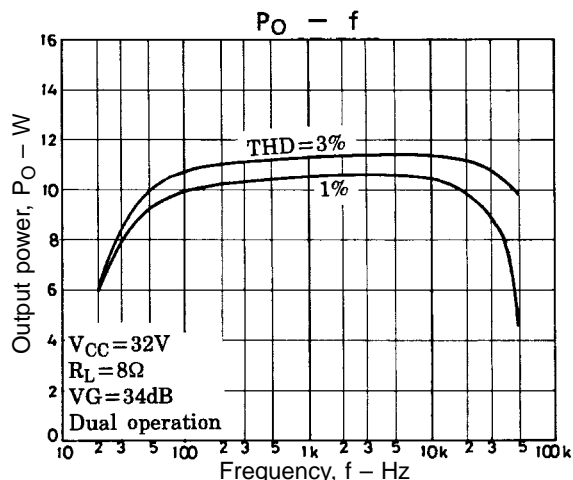
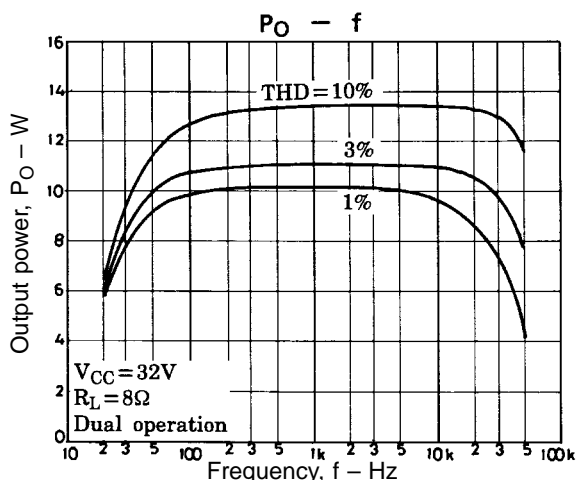

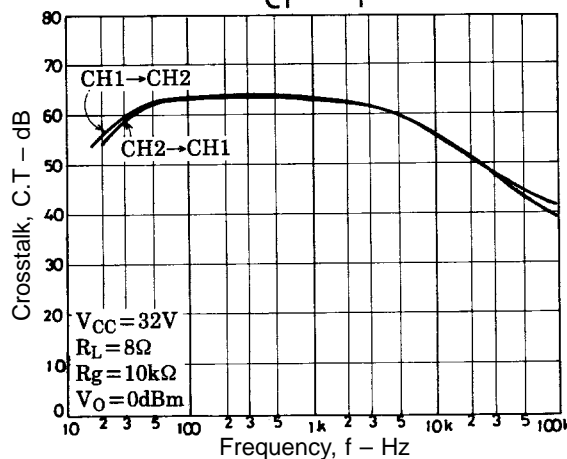
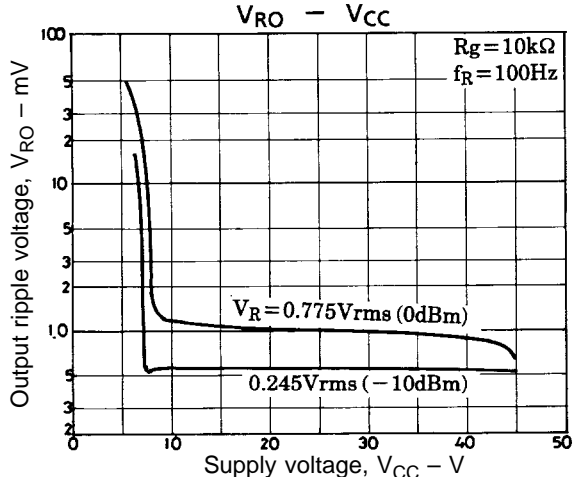
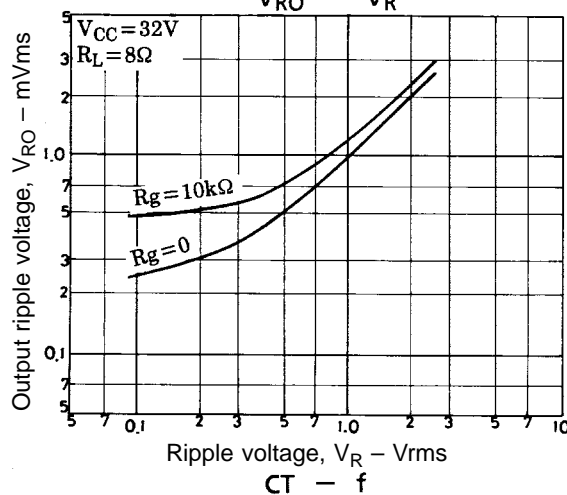
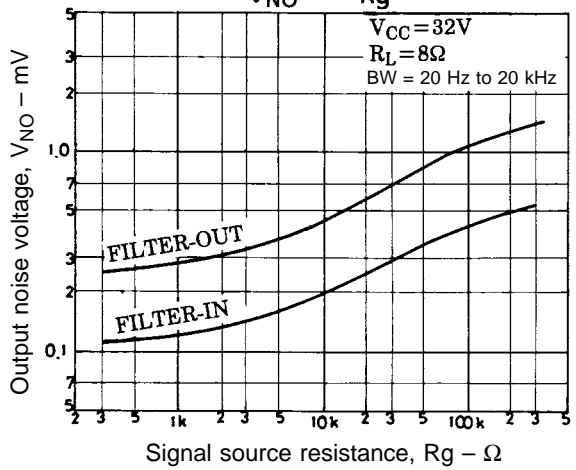
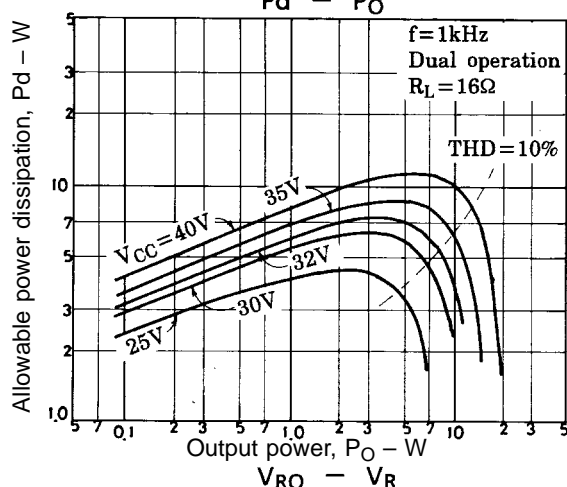
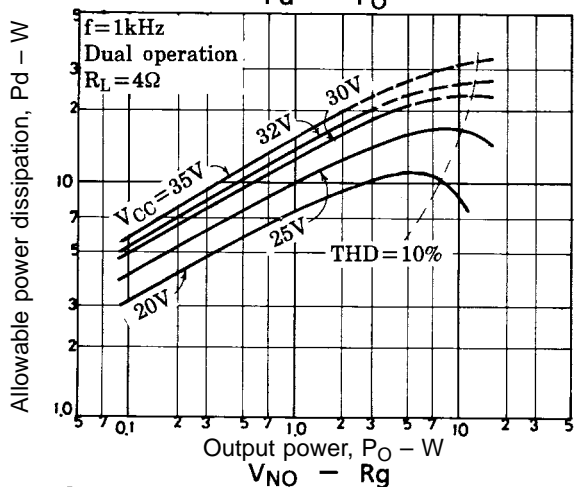
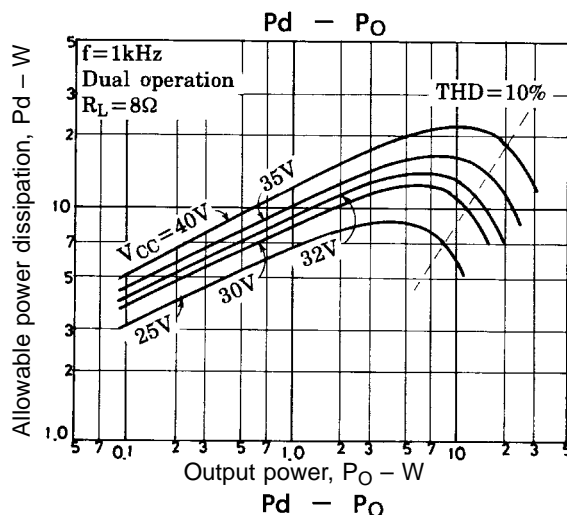
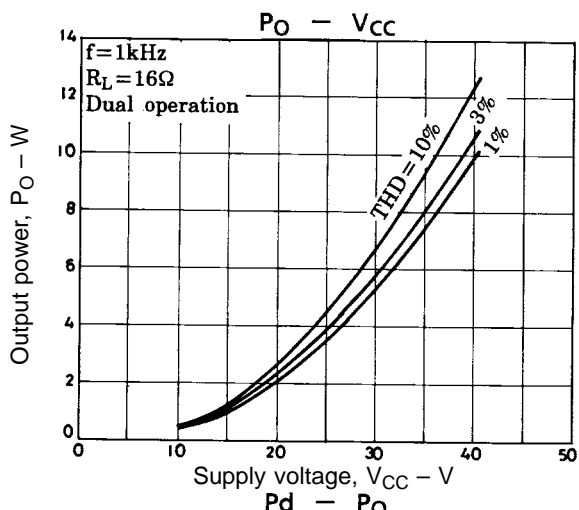

- Specifications of any and all SANYO products described or contained herein stipulate the performance, characteristics, and functions of the described products in the independent state, and are not guarantees of the performance, characteristics, and functions of the described products as mounted in the customer's products or equipment. To verify symptoms and states that cannot be evaluated in an independent device, the customer should always evaluate and test devices mounted in the customer's products or equipment.
- SANYO Electric Co., Ltd. strives to supply high-quality high-reliability products. However, any and all semiconductor products fail with some probability. It is possible that these probabilistic failures could give rise to accidents or events that could endanger human lives, that could give rise to smoke or fire, or that could cause damage to other property. When designing equipment, adopt safety measures so that these kinds of accidents or events cannot occur. Such measures include but are not limited to protective circuits and error prevention circuits for safe design, redundant design, and structural design.
- In the event that any or all SANYO products(including technical data, services) described or contained herein are controlled under any of applicable local export control laws and regulations, such products must not be exported without obtaining the export license from the authorities concerned in accordance with the above law.
- No part of this publication may be reproduced or transmitted in any form or by any means, electronic or mechanical, including photocopying and recording, or any information storage or retrieval system, or otherwise, without the prior written permission of SANYO Electric Co., Ltd.
- Any and all information described or contained herein are subject to change without notice due to product/technology improvement, etc. When designing equipment, refer to the "Delivery Specification" for the SANYO product that you intend to use.
- Information (including circuit diagrams and circuit parameters) herein is for example only ; it is not guaranteed for volume production. SANYO believes information herein is accurate and reliable, but no guarantees are made or implied regarding its use or any infringements of intellectual property rights or other rights of third parties.

This catalog provides information as of February, 1996. Specifications and information herein are subject to change without notice.