

HEXFRED™

HFA15TB60PbF
HFA15TB60-1
 Ultrafast, Soft Recovery Diode

Features

- Ultrafast Recovery
- Ultrasoft Recovery
- Very Low I_{RRM}
- Very Low Q_{rr}
- Specified at Operating Conditions
- Lead-Free

Benefits

- Reduced RFI and EMI
- Reduced Power Loss in Diode and Switching Transistor
- Higher Frequency Operation
- Reduced Snubbing
- Reduced Parts Count

Description

International Rectifier's HFA15TB60 is a state of the art ultra fast recovery diode. Employing the latest in epitaxial construction and advanced processing techniques it features a superb combination of characteristics which result in performance which is unsurpassed by any rectifier previously available. With basic ratings of 600 volts and 8 amps per Leg continuous current, the HFA15TB60 is especially well suited for use as the companion diode for IGBTs and MOSFETs. In addition to ultra fast recovery time, the HEXFRED product line features extremely low values of peak recovery current (I_{RRM}) and does not exhibit any tendency to "snap-off" during the t_b portion of recovery. The HEXFRED features combine to offer designers a rectifier with lower noise and significantly lower switching losses in both the diode and the switching transistor. These HEXFRED advantages can help to significantly reduce snubbing, component count and heatsink sizes. The HEXFRED HFA15TB60 is ideally suited for applications in power supplies and power conversion systems (such as inverters), motor drives, and many other similar applications where high speed, high efficiency is needed.

$V_R = 600V$
$V_F = 1.7V$
$Q_{rr}^* = 84nC$
$di_{(rec)M}/dt^* = 188A/\mu s$
* 125°C

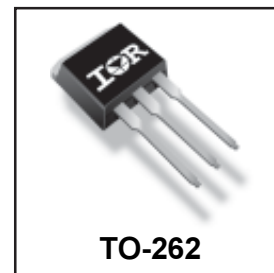

Absolute Maximum Ratings

	Parameter	Max	Units
V_R	Cathode-to-Anode Voltage	600	V
$I_F @ T_C = 100^\circ C$	Continuous Forward Current	15	A
I_{FSM}	Single Pulse Forward Current	150	
I_{FRM}	Maximum Repetitive Forward Current	60	
$P_D @ T_C = 25^\circ C$	Maximum Power Dissipation	74	W
$P_D @ T_C = 100^\circ C$	Maximum Power Dissipation	29	
T_J	Operating Junction and	- 55 to +150	C
T_{STG}	Storage Temperature Range		

Electrical Characteristics @ T_J = 25°C (unless otherwise specified)

	Parameter	Min	Typ	Max	Units	Test Conditions
V _{BR}	Cathode Anode Breakdown Voltage	600			V	I _R = 100μA
V _{FM}	Max Forward Voltage		1.3	1.7	V	I _F = 15A
			1.5	2.0		I _F = 30A
			1.2	1.6		I _F = 15A, T _J = 125°C
I _{RM}	Max Reverse Leakage Current		1.0	10	μA	V _R = V _R Rated
			400	1000		T _J = 125°C, V _R = 0.8 x V _R Rated
C _T	Junction Capacitance		25	50	pF	V _R = 200V
L _S	Series Inductance		8.0		nH	Measured lead to lead 5mm from package body

Dynamic Recovery Characteristics @ T_J = 25°C (unless otherwise specified)

	Parameter	Min	Typ	Max	Units	Test Conditions
t _{rr}	Reverse Recovery Time	19			ns	I _F = 1.0A, di _F /dt = 200A/μs, V _R = 30V
t _{rr1}	See Fig. 5	42	60			T _J = 25°C
t _{rr2}		74	120			T _J = 125°C
I _{RRM1}	Peak Recovery Current See Fig. 6	4.0	6.0		A	T _J = 25°C
I _{RRM2}		6.5	10			T _J = 125°C
Q _{rr1}	Reverse Recovery Charge See Fig. 7	84	180		nC	T _J = 25°C
Q _{rr2}		241	600			T _J = 125°C
di _{(rec)M} /dt1	Peak Rate of Fall of Recovery Current During t _b See Fig. 8	188			A/μs	T _J = 25°C
di _{(rec)M} /dt2		160				T _J = 125°C

Thermal - Mechanical Characteristics

	Parameter	Min	Typ	Max	Units
T _{lead} ①	Lead Temperature			300	°C
R _{thJC}	Thermal Resistance, Junction to Case			1.7	K/W
R _{thJA} ②	Thermal Resistance, Junction to Ambient			80	
R _{thCS} ③	Thermal Resistance, Case to Heat Sink		0.5		
Wt	Weight		2.0		g
			0.07		(oz)
T	Mounting Torque		6.0	12	Kg-cm
			5.0	10	lbf•in

- ① 0.063 in. from Case (1.6mm) for 10 sec
- ② Typical Socket Mount
- ③ Mounting Surface, Flat, Smooth and Greased

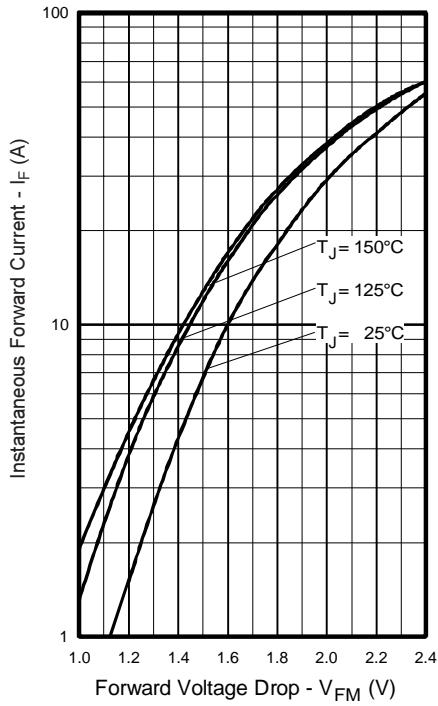

Fig. 1 - Maximum Forward Voltage Drop vs. Instantaneous Forward Current

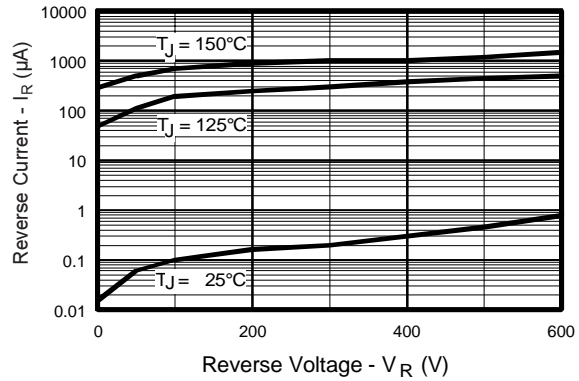

Fig. 2 - Typical Reverse Current vs. Reverse Voltage

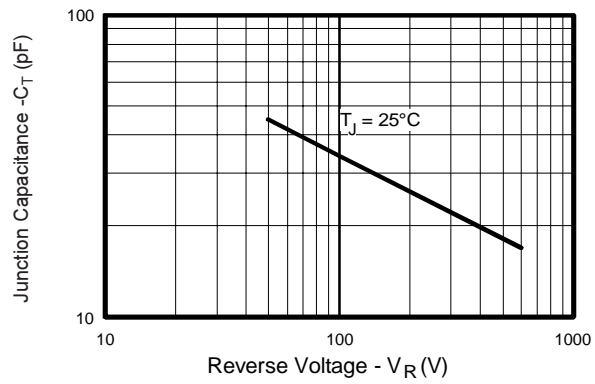

Fig. 3 - Typical Junction Capacitance vs. Reverse Voltage

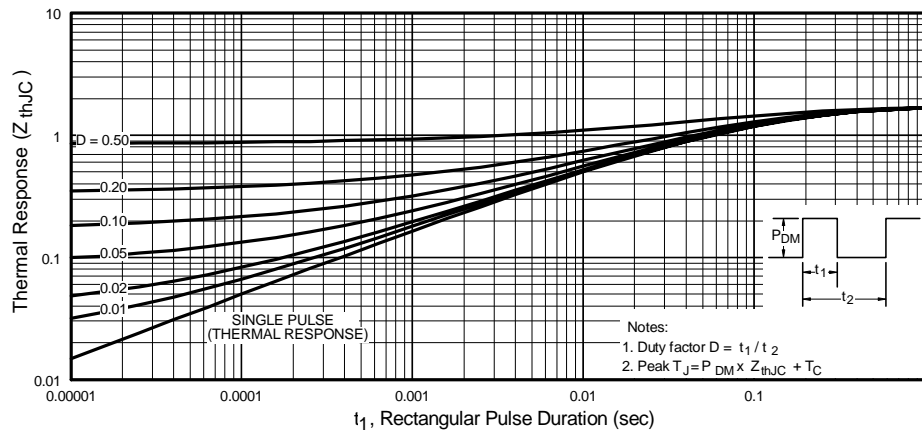

Fig. 4 - Maximum Thermal Impedance Z_{thjc} Characteristics

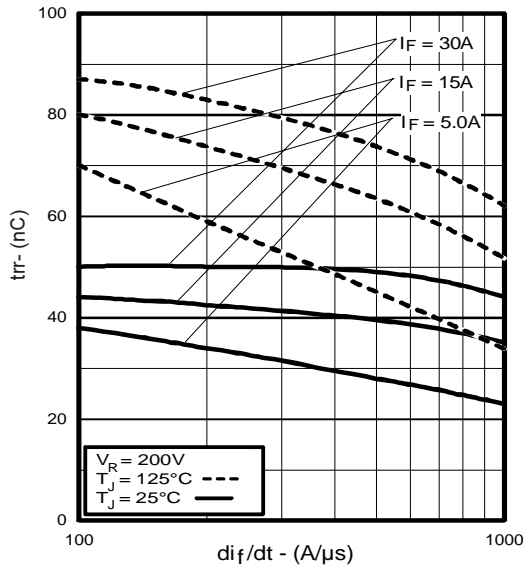

Fig. 5 - Typical Reverse Recovery vs. di_f/dt

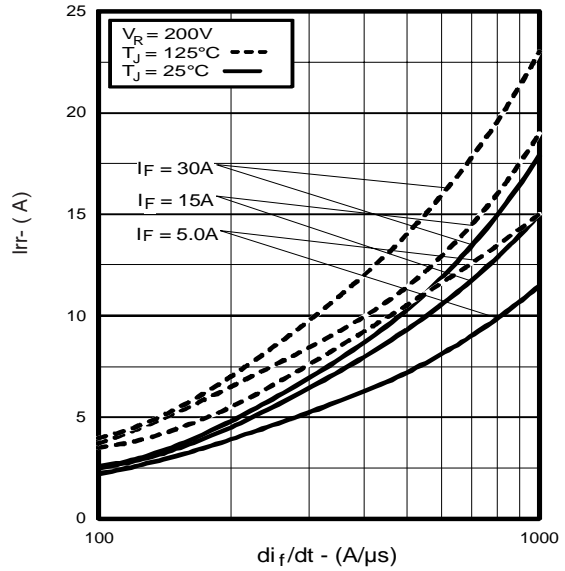

Fig. 6 - Typical Recovery Current vs. di_f/dt

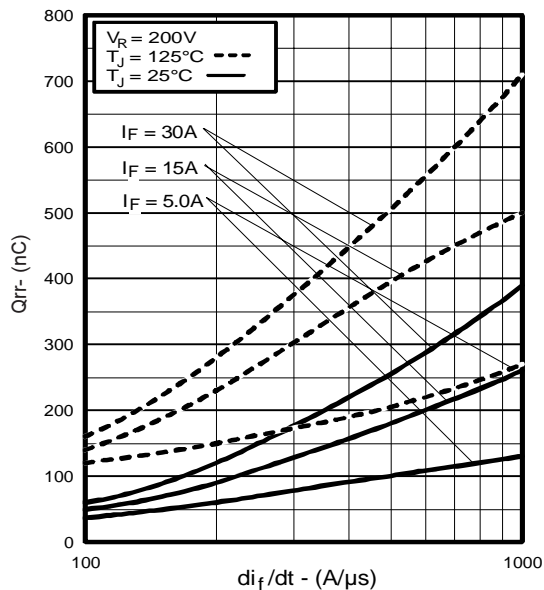

Fig. 7 - Typical Stored Charge vs. di_f/dt

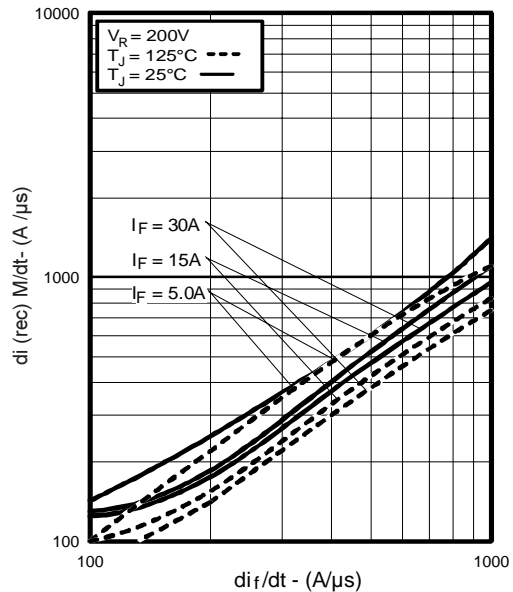

Fig. 8 - Typical $di_{(rec)M}/dt$ vs. di_f/dt

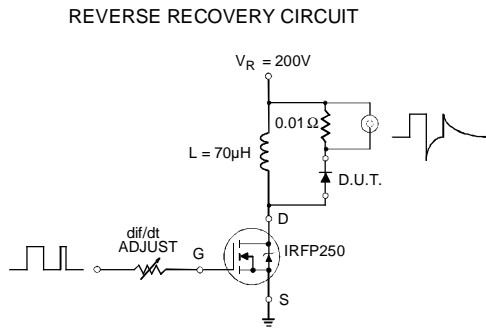

Fig. 9 - Reverse Recovery Parameter Test Circuit

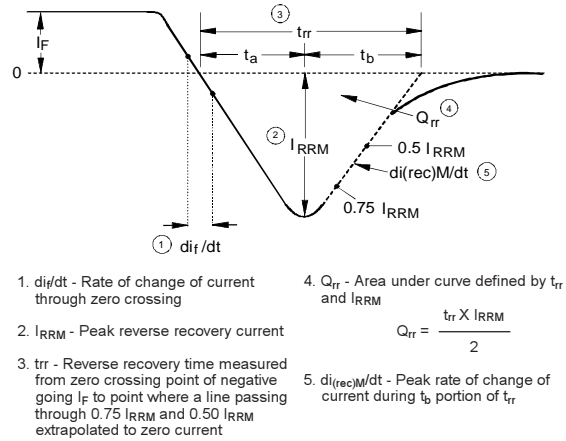
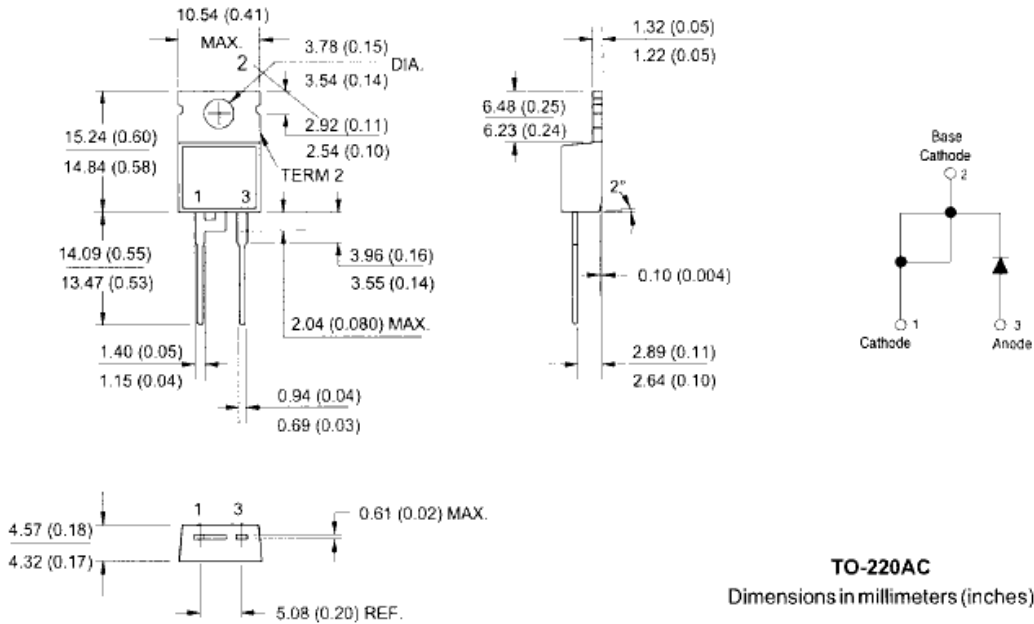

Fig. 10 - Reverse Recovery Waveform and Definitions

HFA15TB60PbF, HFA15TB60-1

TO-220AC Package Outline

Dimensions are shown in millimeters (inches)



TO-220AC
Dimensions in millimeters (inches)

TO-220AC Part Marking Information

EXAMPLE: THIS IS AHFA06TB120
LOT CODE 1789
ASSEMBLED ON WW19, 2001
IN THE ASSEMBLY LINE "C"

Note: "P" in the beginning of date code indicates "Lead-Free"

OR

EXAMPLE: THIS IS AHFA06TB120
LOT CODE 1789
ASSEMBLED ON WW19, 2001
IN THE ASSEMBLY LINE "C"

Note: "P" in assembly line position indicates "Lead-Free"

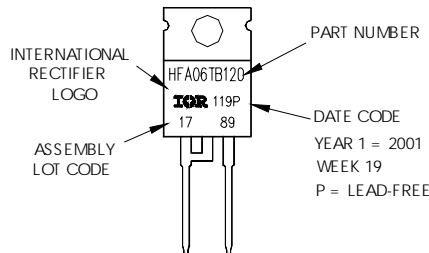
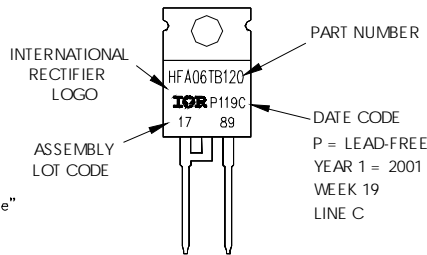

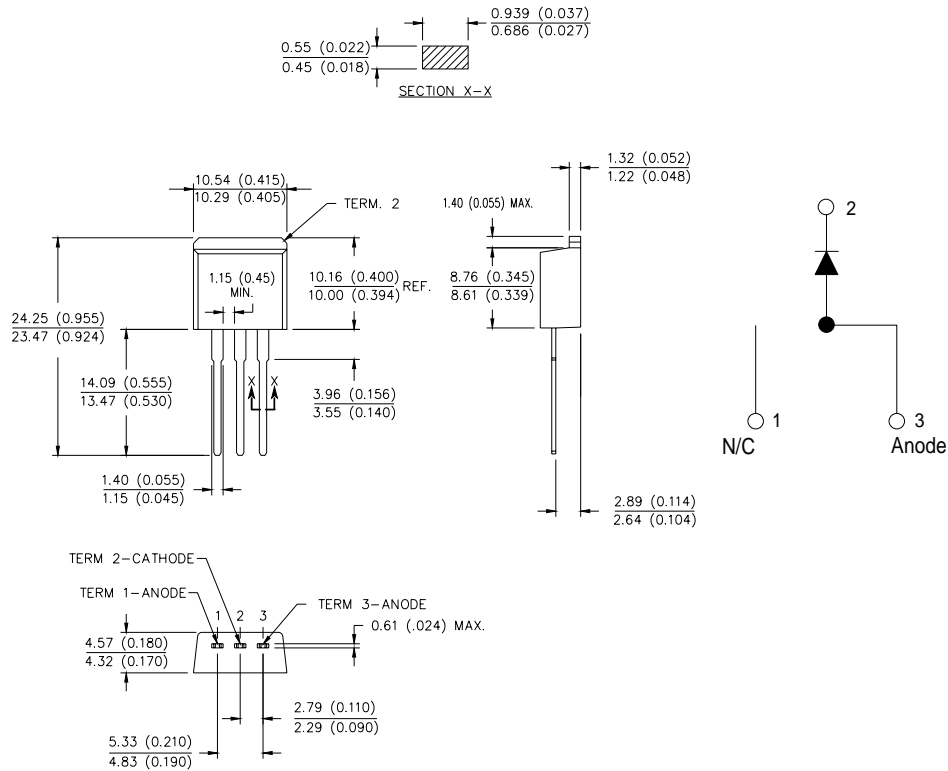

Conforms to JEDEC Outline TO-262
 Dimensions in millimeters and inches

Data and specifications subject to change without notice.
 This product has been designed and qualified for Industrial Level.
 Qualification Standards can be found on IR's Web site.