

BUZ 73L

SIPMOS[®] Power Transistor

- N channel
- Enhancement mode
- Avalanche-rated
- Logic Level
- Pb-free lead plating; RoHS compliant

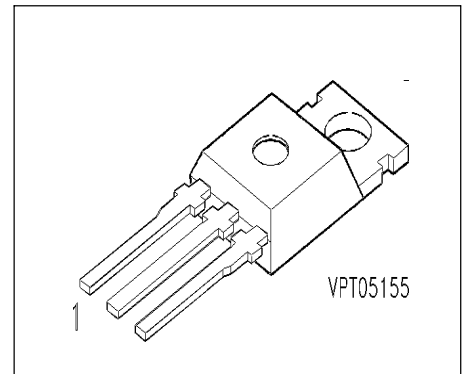

Pin 1	Pin 2	Pin 3
G	D	S

Type	V _{DS}	I _D	R _{DS(on)}	Package	Ordering Code
BUZ 73 L	200 V	7 A	0.4 Ω	PG-TO-220 AB	C67078-S1328-A2

Maximum Ratings

Parameter	Symbol	Values	Unit
Continuous drain current $T_C = 28\text{ °C}$	I_D	7	A
Pulsed drain current $T_C = 25\text{ °C}$	I_{Dpuls}	28	
Avalanche current, limited by T_{jmax}	I_{AR}	7	
Avalanche energy, periodic limited by T_{jmax}	E_{AR}	6.5	mJ
Avalanche energy, single pulse $I_D = 7\text{ A}$, $V_{DD} = 50\text{ V}$, $R_{GS} = 25\text{ Ω}$ $L = 3.67\text{ mH}$, $T_j = 25\text{ °C}$	E_{AS}	120	
Gate source voltage	V_{GS}	± 20	V
ESD-Sensitivity HBM as per MIL-STD 883		Class 1	
Power dissipation $T_C = 25\text{ °C}$	P_{tot}	40	W
Operating temperature	T_j	-55 ... + 150	°C
Storage temperature	T_{stg}	-55 ... + 150	
Thermal resistance, chip case	R_{thJC}	≤ 3.1	K/W
Thermal resistance, chip to ambient	R_{thJA}	75	
DIN humidity category, DIN 40 040		E	
IEC climatic category, DIN IEC 68-1		55 / 150 / 56	

Electrical Characteristics, at $T_j = 25^\circ\text{C}$, unless otherwise specified

Parameter	Symbol	Values			Unit
		min.	typ.	max.	
Static Characteristics					
Drain- source breakdown voltage $V_{GS} = 0\text{ V}, I_D = 0.25\text{ mA}, T_j = 25^\circ\text{C}$	$V_{(BR)DSS}$	200	-	-	V
Gate threshold voltage $V_{GS} = V_{DS}, I_D = 1\text{ mA}$	$V_{GS(th)}$	1.2	1.6	2	
Zero gate voltage drain current $V_{DS} = 200\text{ V}, V_{GS} = 0\text{ V}, T_j = 25^\circ\text{C}$ $V_{DS} = 200\text{ V}, V_{GS} = 0\text{ V}, T_j = 125^\circ\text{C}$	I_{DSS}	-	0.1 10	1 100	μA
Gate-source leakage current $V_{GS} = 20\text{ V}, V_{DS} = 0\text{ V}$	I_{GSS}	-	10	100	nA
Drain-Source on-resistance $V_{GS} = 5\text{ V}, I_D = 3.5\text{ A}$	$R_{DS(on)}$	-	0.3	0.4	Ω

Electrical Characteristics, at $T_j = 25^\circ\text{C}$, unless otherwise specified

Parameter	Symbol	Values			Unit
		min.	typ.	max.	
Dynamic Characteristics					
Transconductance $V_{DS} \geq 2 \cdot I_D \cdot R_{DS(on)max}, I_D = 3.5 \text{ A}$	g_{fs}	5	6.5	-	S
Input capacitance $V_{GS} = 0 \text{ V}, V_{DS} = 25 \text{ V}, f = 1 \text{ MHz}$	C_{iss}	-	630	840	pF
Output capacitance $V_{GS} = 0 \text{ V}, V_{DS} = 25 \text{ V}, f = 1 \text{ MHz}$	C_{oss}	-	120	200	
Reverse transfer capacitance $V_{GS} = 0 \text{ V}, V_{DS} = 25 \text{ V}, f = 1 \text{ MHz}$	C_{rss}	-	60	90	
Turn-on delay time $V_{DD} = 30 \text{ V}, V_{GS} = 5 \text{ V}, I_D = 3 \text{ A}$ $R_{GS} = 50 \Omega$	$t_{d(on)}$	-	15	20	ns
Rise time $V_{DD} = 30 \text{ V}, V_{GS} = 5 \text{ V}, I_D = 3 \text{ A}$ $R_{GS} = 50 \Omega$	t_r	-	60	90	
Turn-off delay time $V_{DD} = 30 \text{ V}, V_{GS} = 5 \text{ V}, I_D = 3 \text{ A}$ $R_{GS} = 50 \Omega$	$t_{d(off)}$	-	100	130	
Fall time $V_{DD} = 30 \text{ V}, V_{GS} = 5 \text{ V}, I_D = 3 \text{ A}$ $R_{GS} = 50 \Omega$	t_f	-	40	50	

Electrical Characteristics, at $T_j = 25^\circ\text{C}$, unless otherwise specified

Parameter	Symbol	Values			Unit
		min.	typ.	max.	
Reverse Diode					
Inverse diode continuous forward current $T_C = 25^\circ\text{C}$	I_S	-	-	7	A
Inverse diode direct current, pulsed $T_C = 25^\circ\text{C}$	I_{SM}	-	-	28	
Inverse diode forward voltage $V_{GS} = 0\text{ V}, I_F = 14\text{ A}$	V_{SD}	-	1.1	1.7	V
Reverse recovery time $V_R = 100\text{ V}, I_F = I_S, di_F/dt = 100\text{ A}/\mu\text{s}$	t_{rr}	-	140	-	ns
Reverse recovery charge $V_R = 100\text{ V}, I_F = I_S, di_F/dt = 100\text{ A}/\mu\text{s}$	Q_{rr}	-	0.7	-	μC

Power dissipation

$P_{tot} = f(T_C)$

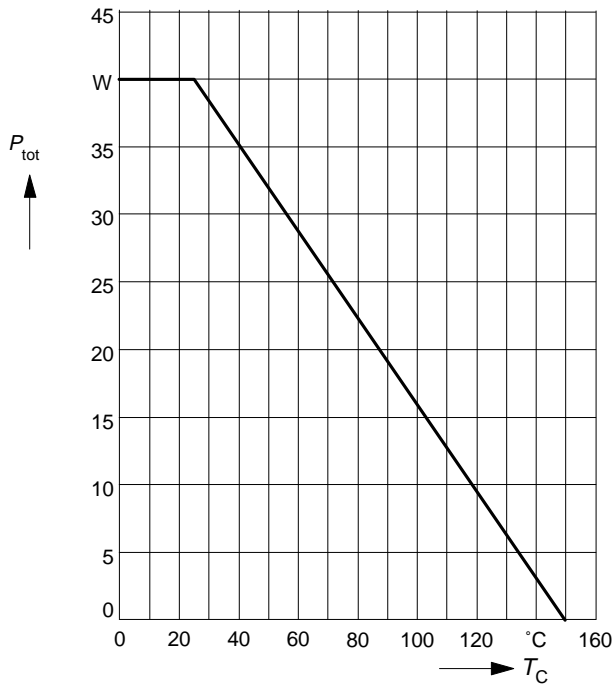

Drain current

$I_D = f(T_C)$
parameter: $V_{GS} \geq 5V$

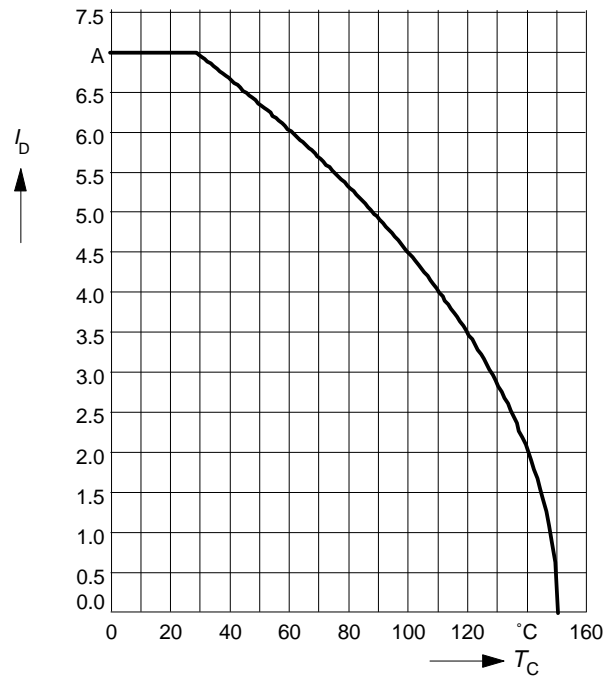

Safe operating area

$I_D = f(V_{DS})$
parameter: $D = 0.01, T_C = 25^\circ C$

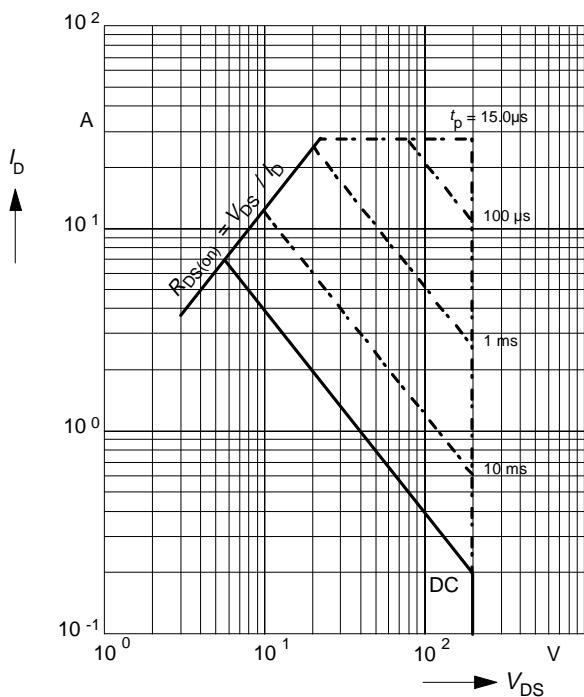

Transient thermal impedance

$Z_{thJC} = f(t_p)$
parameter: $D = t_p / T$

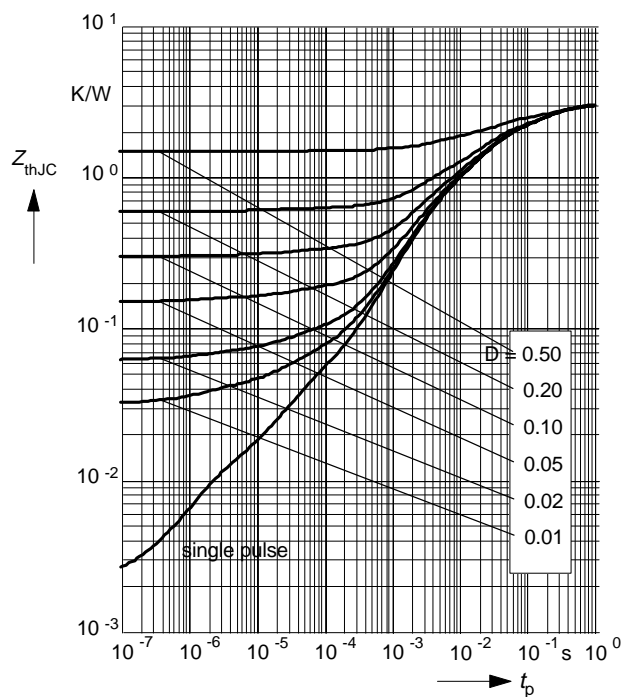

Typ. output characteristics

$I_D = f(V_{DS})$

parameter: $t_p = 80 \mu s$

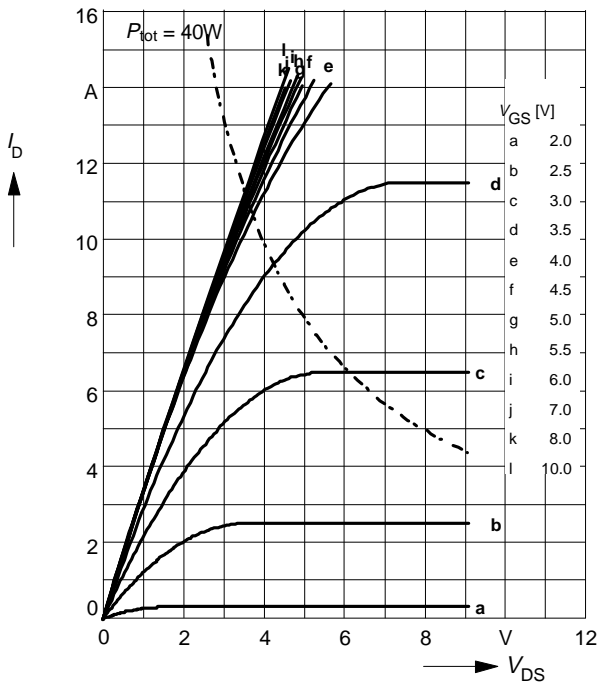

Typ. drain-source on-resistance

$R_{DS(on)} = f(I_D)$

parameter: V_{GS}

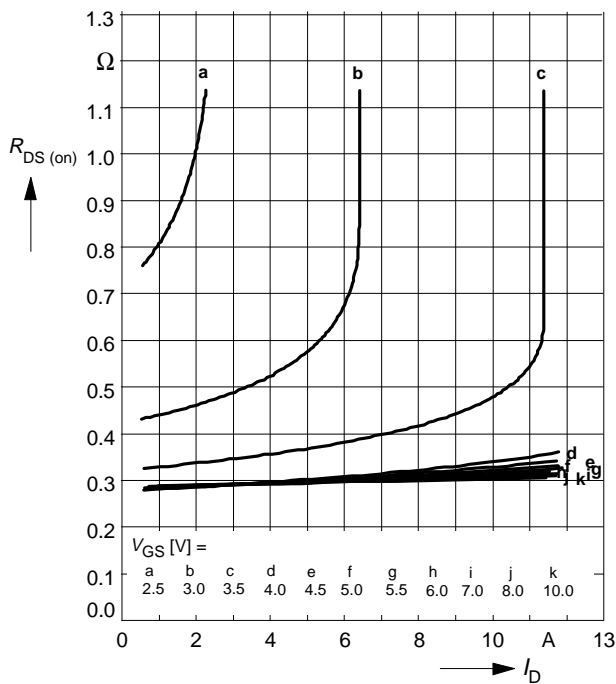

Typ. transfer characteristics $I_D = f(V_{GS})$

parameter: $t_p = 80 \mu s$

$V_{DS} \geq 2 \times I_D \times R_{DS(on)max}$

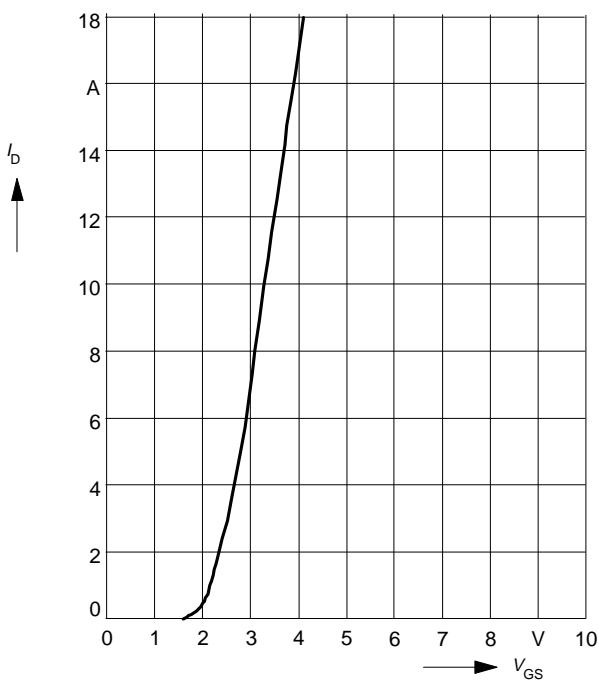

Typ. forward transconductance $g_{fs} = f(I_D)$

parameter: $t_p = 80 \mu s$,

$V_{DS} \geq 2 \times I_D \times R_{DS(on)max}$

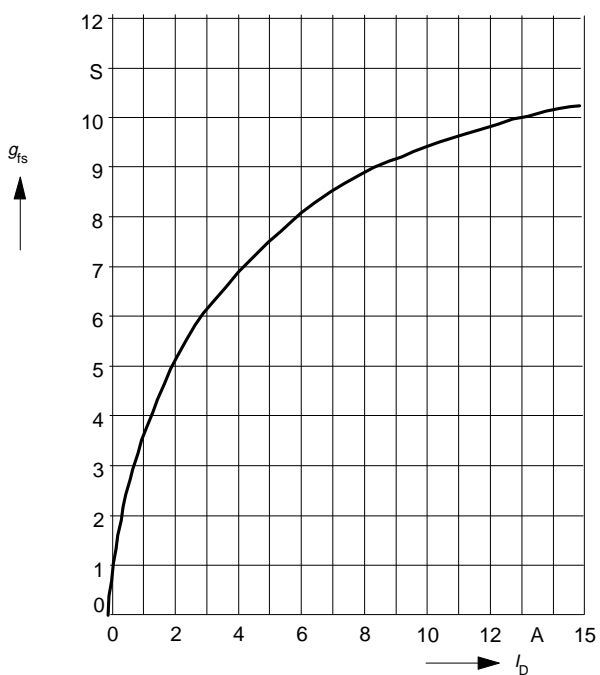

Drain-source on-resistance

$$R_{DS(on)} = f(T_j)$$

parameter: $I_D = 3.5\text{ A}$, $V_{GS} = 5\text{ V}$

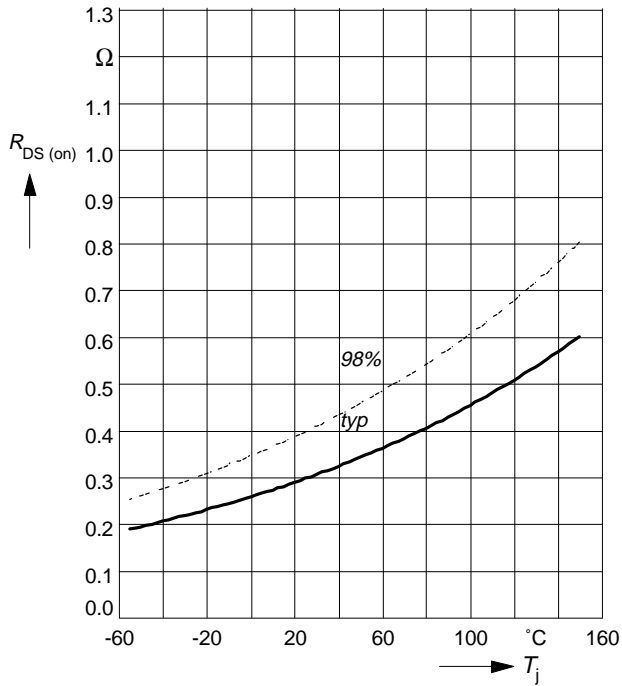

Gate threshold voltage

$$V_{GS(th)} = f(T_j)$$

parameter: $V_{GS} = V_{DS}$, $I_D = 1\text{ mA}$

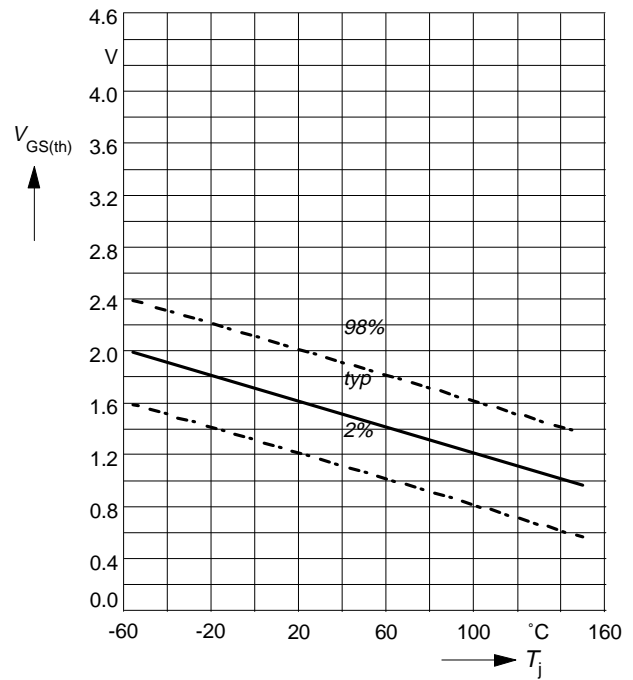

Typ. capacitances

$$C = f(V_{DS})$$

parameter: $V_{GS} = 0\text{ V}$, $f = 1\text{ MHz}$

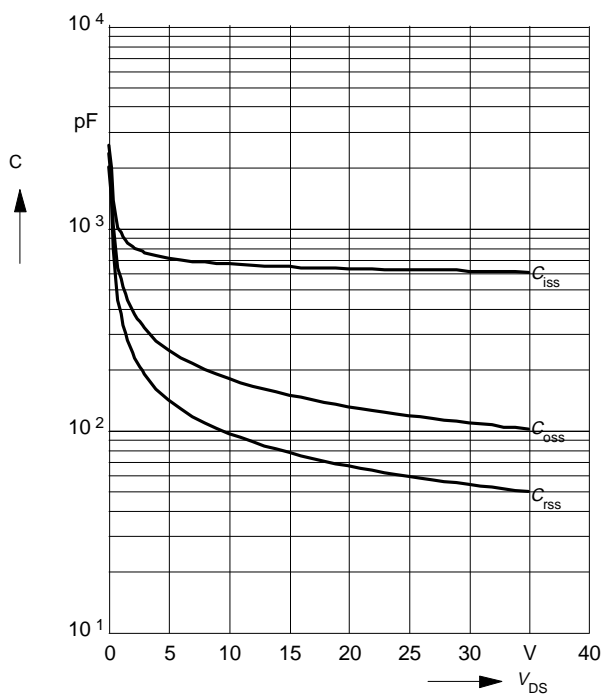

Forward characteristics of reverse diode

$$I_F = f(V_{SD})$$

parameter: T_j , $t_p = 80\text{ }\mu\text{s}$

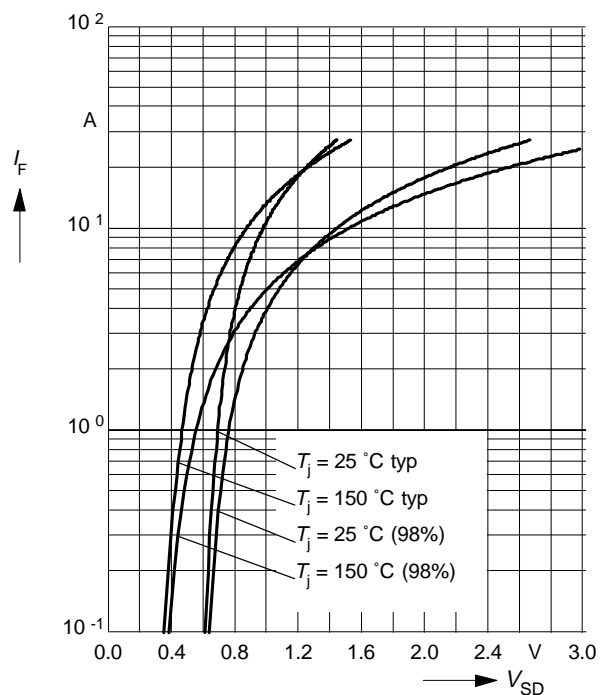

Avalanche energy $E_{AS} = f(T_j)$
 parameter: $I_D = 7\text{ A}$, $V_{DD} = 50\text{ V}$
 $R_{GS} = 25\ \Omega$, $L = 3.67\text{ mH}$

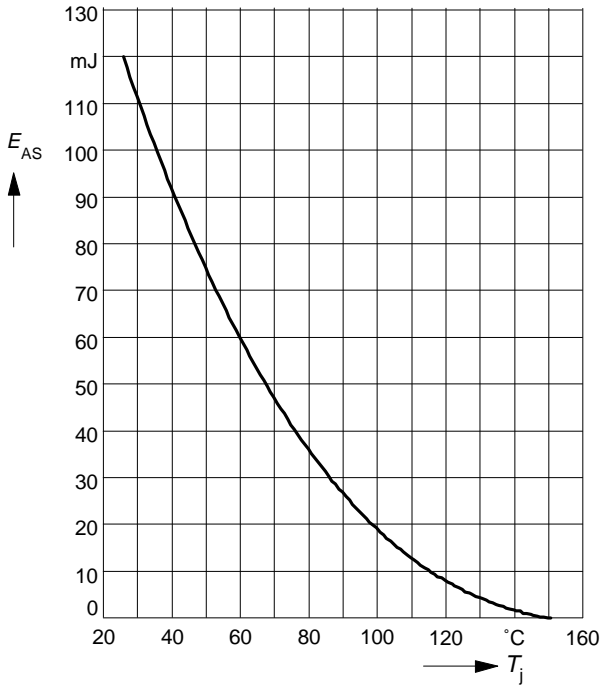

Typ. gate charge
 $V_{GS} = f(Q_{Gate})$
 parameter: $I_{D\text{ puls}} = 63\text{ A}$

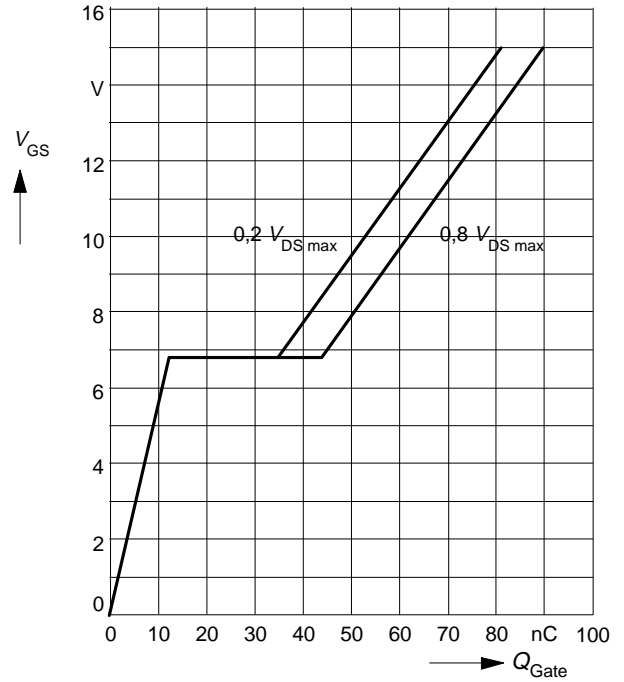

Drain-source breakdown voltage
 $V_{(BR)DSS} = f(T_j)$

