

## Silicon NPN Phototransistor, RoHS Compliant



94 8401

### DESCRIPTION

BPW77 is a silicon NPN phototransistor with high radiant sensitivity in hermetically sealed TO-18 package with base terminal and glass lens. It is sensitive to visible and near infrared radiation.

### FEATURES

- Package type: leaded
- Package form: TO-18
- Dimensions (in mm): Ø 4.7
- High photo sensitivity
- High radiant sensitivity
- Suitable for visible and near infrared radiation
- Fast response times
- Angle of half sensitivity:  $\phi = \pm 10^\circ$
- Base terminal connected
- Hermetically sealed package
- Lead (Pb)-free component in accordance with RoHS 2002/95/EC and WEEE 2002/96/EC



RoHS  
COMPLIANT

### APPLICATIONS

- Detector in electronic control and drive circuits

PRODUCT SUMMARY			
COMPONENT	$I_{ca}$ (mA)	$\phi$ (deg)	$\lambda_{0.1}$ (nm)
BPW77NA	7.5 to 15	$\pm 10$	450 to 1080
BPW77NB	> 10	$\pm 10$	450 to 1080

**Note**

Test condition see table "Basic Characteristics"

ORDERING INFORMATION			
ORDERING CODE	PACKAGING	REMARKS	PACKAGE FORM
BPW77NA	Bulk	MOQ: 1000 pcs, 1000 pcs/bulk	TO-18
BPW77NB	Bulk	MOQ: 1000 pcs, 1000 pcs/bulk	TO-18

**Note**

MOQ: minimum order quantity

ABSOLUTE MAXIMUM RATINGS				
PARAMETER	TEST CONDITION	SYMBOL	VALUE	UNIT
Collector base voltage		$V_{CBO}$	80	V
Collector emitter voltage		$V_{CEO}$	70	V
Emitter base voltage		$V_{EBO}$	5	V
Collector current		$I_C$	50	mA
Collector peak current	$t_p/T = 0.5, t_p \leq 10$ ms	$I_{CM}$	100	mA
Total power dissipation	$T_{amb} \leq 25$ °C	$P_V$	250	mW
Junction temperature		$T_j$	125	°C
Operating temperature range		$T_{amb}$	- 40 to + 125	°C
Storage temperature range		$T_{stg}$	- 40 to + 125	°C
Soldering temperature	$t \leq 5$ s	$T_{sd}$	260	°C
Thermal resistance junction/ambient	Connected with Cu wire, 0.14 mm <sup>2</sup>	$R_{thJA}$	400	K/W
Thermal resistance junction/gase		$R_{thJC}$	150	K/W

**Note**

$T_{amb} = 25$  °C, unless otherwise specified



Fig. 1 - Power Dissipation Limit vs. Ambient Temperature

BASIC CHARACTERISTICS						
PARAMETER	TEST CONDITION	SYMBOL	MIN.	TYP.	MAX.	UNIT
Collector emitter breakdown voltage	$I_C = 1 \text{ mA}$	$V_{(BR)CEO}$	70			V
Collector emitter dark current	$V_{CE} = 20 \text{ V}, E = 0$	$I_{CEO}$		1	100	nA
Collector emitter capacitance	$V_{CE} = 5 \text{ V}, f = 1 \text{ MHz}, E = 0$	$C_{CEO}$		6		pF
Angle of half sensitivity		$\phi$		$\pm 10$		deg
Wavelength of peak sensitivity		$\lambda_p$		850		nm
Range of spectral bandwidth		$\lambda_{0.1}$		450 to 1080		nm
Collector emitter saturation voltage	$E_e = 1 \text{ mW/cm}^2, \lambda = 950 \text{ nm}, I_C = 1 \text{ mA}$	$V_{CEsat}$		0.15	0.3	V
Turn-on time	$V_S = 5 \text{ V}, I_C = 5 \text{ mA}, R_L = 100 \Omega$	$t_{on}$		6		$\mu\text{s}$
Turn-off time	$V_S = 5 \text{ V}, I_C = 5 \text{ mA}, R_L = 100 \Omega$	$t_{off}$		5		$\mu\text{s}$
Cut-off frequency	$V_S = 5 \text{ V}, I_C = 5 \text{ mA}, R_L = 100 \Omega$	$f_c$		110		kHz

**Note**
 $T_{amb} = 25 \text{ }^\circ\text{C}$ , unless otherwise specified

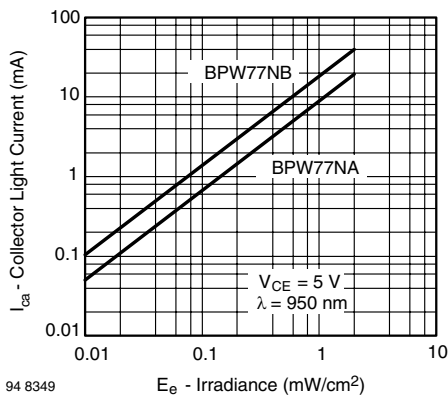
TYPE DEDICATED CHARACTERISTICS							
PARAMETER	TEST CONDITION	PART	SYMBOL	MIN.	TYP.	MAX.	UNIT
Collector light current	$E_e = 1 \text{ mW/cm}^2, \lambda = 950 \text{ nm}, V_{CE} = 5 \text{ V}$	BPW77NA	$I_{ca}$	7.5		15	mA
		BPW77NB	$I_{ca}$	10			mA

**BASIC CHARACTERISTICS**
 $T_{amb} = 25 \text{ }^\circ\text{C}$ , unless otherwise specified


Fig. 2 - Collector Dark Current vs. Ambient Temperature

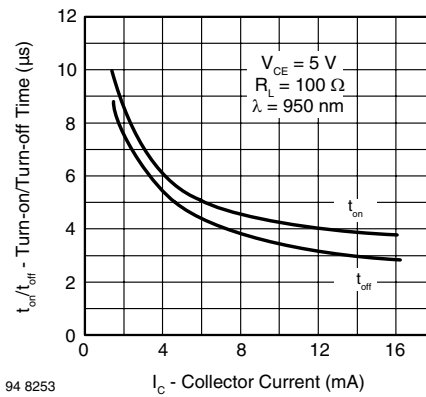


Fig. 3 - Relative Collector Current vs. Ambient Temperature



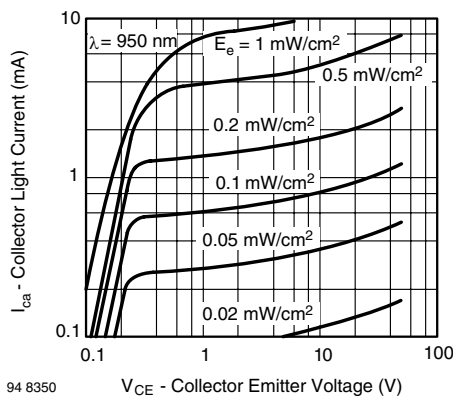
94 8349

Fig. 4 - Collector Light Current vs. Irradiance



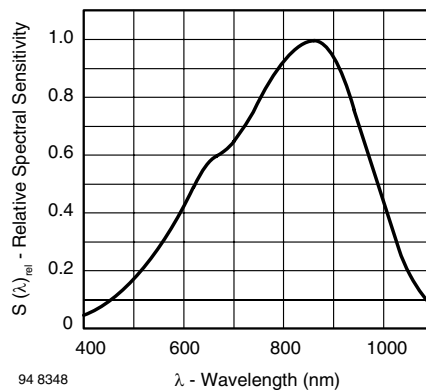
94 8253

Fig. 7 - Turn-on/Turn-off Time vs. Collector Current



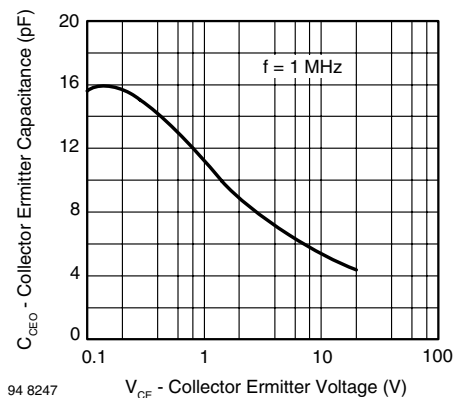
94 8350

Fig. 5 - Collector Light Current vs. Collector Emitter Voltage



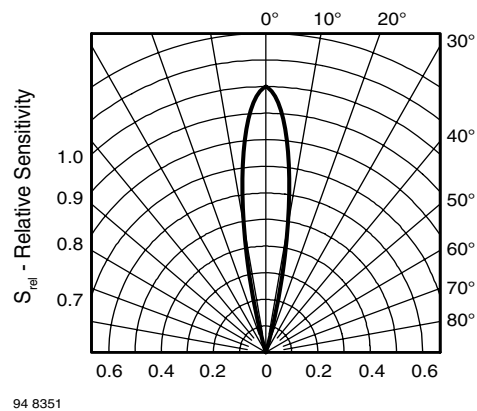
94 8348

Fig. 8 - Relative Spectral Sensitivity vs. Wavelength



94 8247

Fig. 6 - Collector Emitter Capacitance vs. Collector Emitter Voltage



94 8351

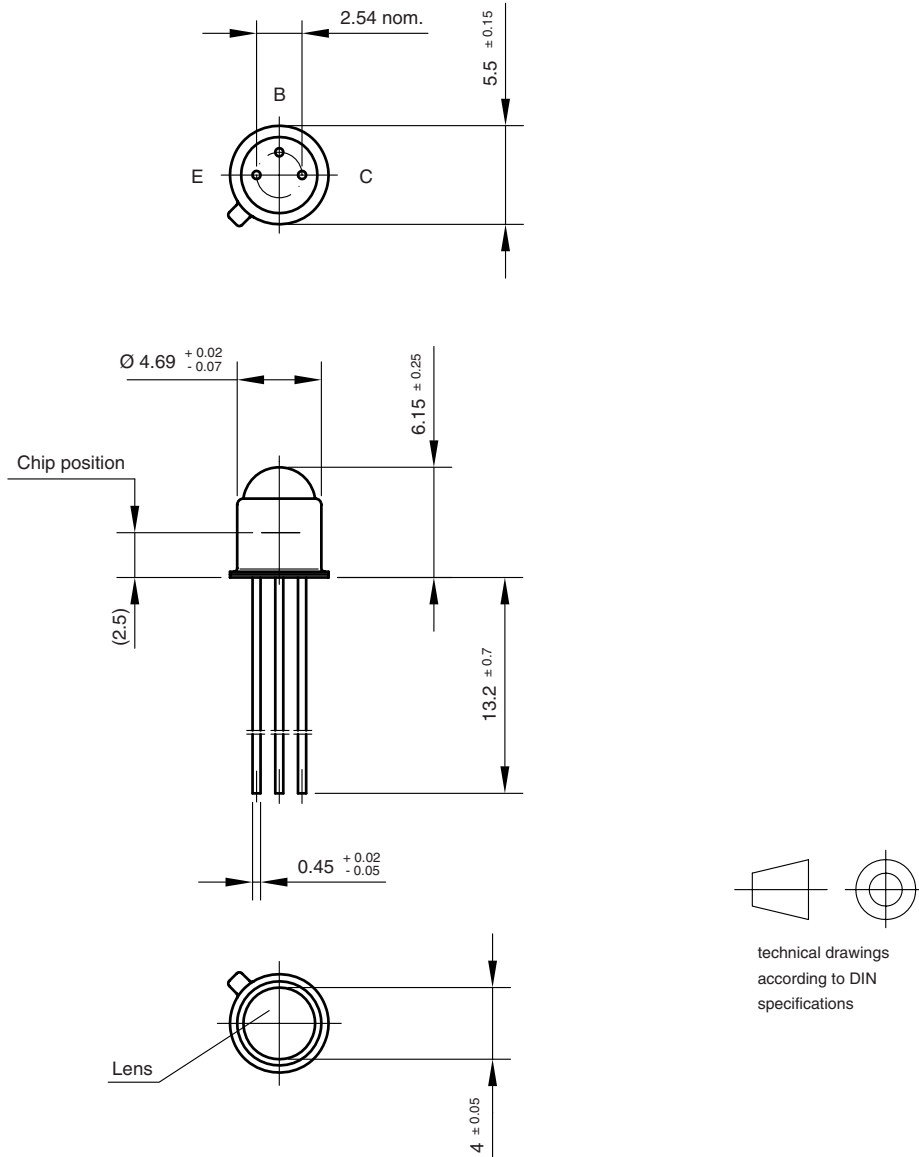
Fig. 9 - Relative Radiant Sensitivity vs. Angular Displacement



# BPW77NA, BPW77NB

Silicon NPN Phototransistor, RoHS Compliant Vishay Semiconductors

## PACKAGE DIMENSIONS in millimeters



Drawing-No.: 6.503-5023.01-4  
Issue: 1; 01.07.96  
96 12180



## Disclaimer

ALL PRODUCT, PRODUCT SPECIFICATIONS AND DATA ARE SUBJECT TO CHANGE WITHOUT NOTICE TO IMPROVE RELIABILITY, FUNCTION OR DESIGN OR OTHERWISE.

Vishay Intertechnology, Inc., its affiliates, agents, and employees, and all persons acting on its or their behalf (collectively, "Vishay"), disclaim any and all liability for any errors, inaccuracies or incompleteness contained in any datasheet or in any other disclosure relating to any product.

Vishay makes no warranty, representation or guarantee regarding the suitability of the products for any particular purpose or the continuing production of any product. To the maximum extent permitted by applicable law, Vishay disclaims (i) any and all liability arising out of the application or use of any product, (ii) any and all liability, including without limitation special, consequential or incidental damages, and (iii) any and all implied warranties, including warranties of fitness for particular purpose, non-infringement and merchantability.

Statements regarding the suitability of products for certain types of applications are based on Vishay's knowledge of typical requirements that are often placed on Vishay products in generic applications. Such statements are not binding statements about the suitability of products for a particular application. It is the customer's responsibility to validate that a particular product with the properties described in the product specification is suitable for use in a particular application. Parameters provided in datasheets and/or specifications may vary in different applications and performance may vary over time. All operating parameters, including typical parameters, must be validated for each customer application by the customer's technical experts. Product specifications do not expand or otherwise modify Vishay's terms and conditions of purchase, including but not limited to the warranty expressed therein.

Except as expressly indicated in writing, Vishay products are not designed for use in medical, life-saving, or life-sustaining applications or for any other application in which the failure of the Vishay product could result in personal injury or death. Customers using or selling Vishay products not expressly indicated for use in such applications do so at their own risk. Please contact authorized Vishay personnel to obtain written terms and conditions regarding products designed for such applications.

No license, express or implied, by estoppel or otherwise, to any intellectual property rights is granted by this document or by any conduct of Vishay. Product names and markings noted herein may be trademarks of their respective owners.

## Material Category Policy

**Vishay Intertechnology, Inc. hereby certifies that all its products that are identified as RoHS-Compliant fulfill the definitions and restrictions defined under Directive 2011/65/EU of The European Parliament and of the Council of June 8, 2011 on the restriction of the use of certain hazardous substances in electrical and electronic equipment (EEE) - recast, unless otherwise specified as non-compliant.**

**Please note that some Vishay documentation may still make reference to RoHS Directive 2002/95/EC. We confirm that all the products identified as being compliant to Directive 2002/95/EC conform to Directive 2011/65/EU.**

**Vishay Intertechnology, Inc. hereby certifies that all its products that are identified as Halogen-Free follow Halogen-Free requirements as per JEDEC JS709A standards. Please note that some Vishay documentation may still make reference to the IEC 61249-2-21 definition. We confirm that all the products identified as being compliant to IEC 61249-2-21 conform to JEDEC JS709A standards.**